

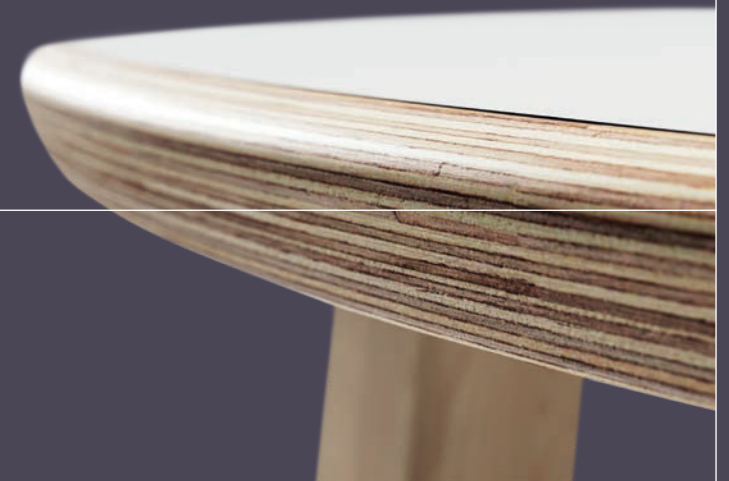

**DESIGNED FOR PEACE OF MIND**



**Pineapple**

	When we design furniture for some of the most difficult environments imaginable,	<b>DESIGNED FOR PEACE OF MIND</b>	
	the first thing we do is listen. Listen to our customers' unique challenges, their day to		
	day needs and above all, who they need to look after.		
	Listening is the first step of the 'Pineapple Process', helping us to find furniture that		
	precisely solves the problem. If we don't have something suitable, we create it.		
	Innovative solutions, technical expertise and thoughtful design, we take pride in		
	creating furniture that's exactly fit for purpose.		
	Our customers get mindfully designed furniture that works effortlessly and looks		
	great. But much more than that, they can go to work knowing they've done		
	everything they can to create a calm environment.		





## IT ALL BEGAN IN

Our founder, William Hathorn, started our company in a workshop in London, England. Originally trading as Pine Productions, based on the popular wood we used to build our furniture, we crafted strong, durable products using traditional carpentry methods. But as our business grew and we began to provide furniture in a variety of materials for the healthcare market, the name no longer fitted. So, with a nod to our beginnings, we took a bold step and became Pineapple.

As our reputation for designing for demanding environments grew, so did demand for our products and we soon expanded into new premises, doubling our production capacity. We started creating technically advanced furniture for secure settings like mental health units and prisons, as well as lower risk spaces like hospitals, healthcare and education facilities.

# 1975



# TODAY

## 45 YEARS OF INNOVATION

We continue to create innovative furniture to deliver real-life solutions for our customers and, from initial concept right through to manufacture and delivery, we have full control of the process. All of our designs are either manufactured by us or by our carefully chosen partners who produce our furniture under license to meet our precise specification and design.

While our business is now international and our vision more ambitious than ever, we're still a family business at heart. Our work ethic and attention to detail is exactly the same as when we started in 1975.



THE PINEAPPLE PROCESS

# We listen

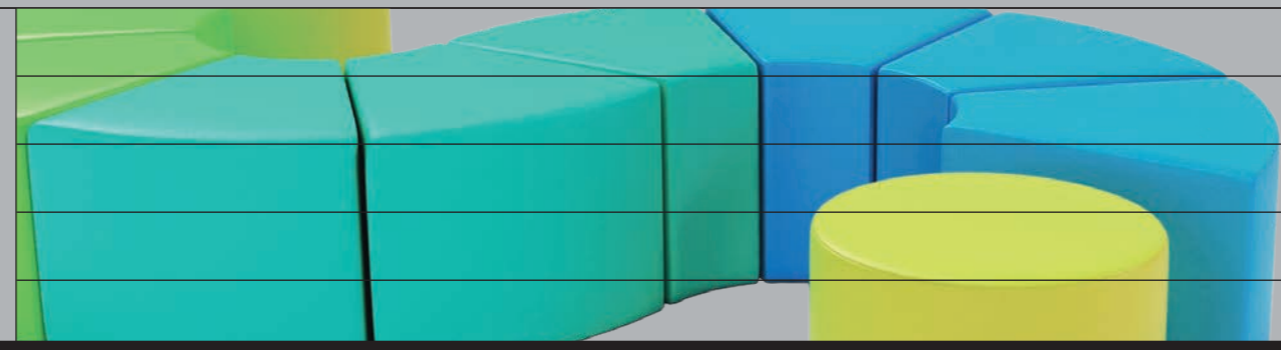

01

We listen more widely and more deeply to our customers' unique set of challenges; they might be safety concerns, maintenance issues or limited space. With forty years of experience under our belts, we're good at listening and know the right questions to ask.

02

# understand

Drawing on the expertise of our Global Advisory Board and our knowledge of best practise, we identify solutions that fit each brief. Then we define exactly what your furniture needs to deliver purpose for your environment, taking physical, functional and emotional needs into account.

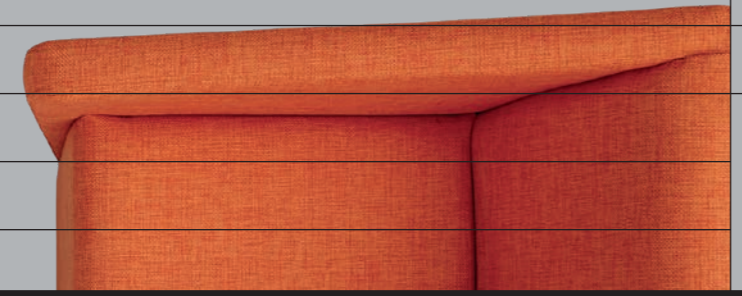
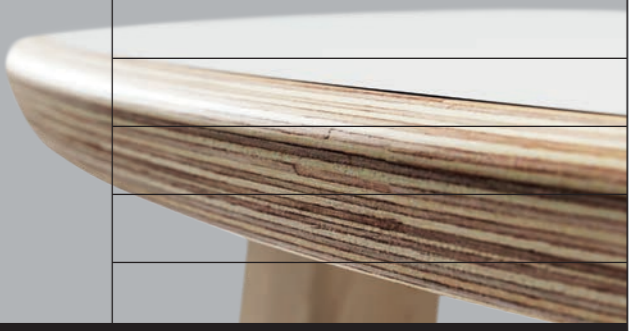

03

# match

Now we understand your environment and precise needs, we can match you with the right products that will solve them. With hundreds of ranges to choose from, there is usually a solution that fits but if there isn't, we'll work with you to create one.

04

We deliver mindfully designed furniture that is exactly fit for purpose. We continue to learn from each new project, building the knowledge we gain into our new and existing product ranges to make them safer than ever.

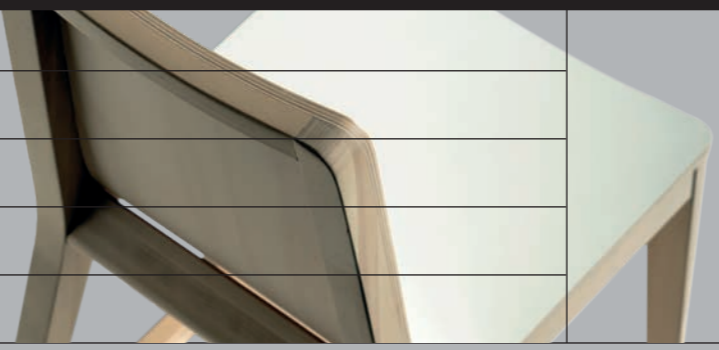

# deliver





We helped to create an inclusive, healing space for this mental health inpatient unit in Northern Ireland.

# BELFAST CITY HOSPITAL



*Reinforced furniture was used to create a tranquil environment which is relaxing and safe in equal measure*



From the outset, Belfast Health and Social Care Trust's recently opened Acute Mental Health Inpatient Unit was designed to be an inclusive, healing space for its residents. The unit comprises 80 bedrooms, 6 psychiatric intensive care unit (PICU) beds and variety of gardens and shared spaces.

With careful upholstery selection, reinforced furniture was used to create a tranquil environment which is relaxing and safe in equal measure.

In the communal lounges, Rubus sofas provide sturdy durable seating, paired with Cumulus coffee tables in a bespoke wood-effect finish, while Cumulus dining tables with matching wood-effect tops and Eclipse chairs create an informal dining/study space.

Reinforced Skye Plus and modular Ohio Plus offer relaxed seating throughout the building, while Snug Plus modular units have been used to create a variety of cosy layouts to suit each space.





Bespoke fitted cabinetry and brightly coloured furniture helped to create a safe, homely environment for this child-focused home.

# LANSDOWNE CHILDREN'S CENTRE



Lansdowne Children's Home is a purpose-built secure children's home in East Sussex which provides accommodation and education facilities for young people, focusing on the educational, emotional and physical wellbeing of the children.

For the TV rooms and other communal spaces, we designed and installed bespoke fitted cabinetry to provide securely lockable storage space. The blues, greens and muted pink finish of the cabinetry follows the therapeutic colour palette seen throughout the building.

Ryno® dining chairs (weighted to 56kg to prevent misuse) were coupled with Cumulus Plus tables (weighted to 71kg) to provide safe and stylish furniture for dining or other activities.

All-foam Cascade Plus chairs provide soft seating with a tear-resistant anti-vandal cover. Heat welded seams make the chairs totally water-resistant which means they can be thoroughly cleaned and dry quickly, ready to be used again.





Providing easy access to good quality outdoor space was one of this building's fundamental design principles.

# ST ANN'S HOSPITAL



*"We selected Pineapple because of their excellent knowledge of the healthcare sector and their range of products suitable for high-risk environments"*



Throughout the ward corridors and outside garden areas our Ryno® benches and Ryno® stools were selected to provide areas of rest and relaxation.

Our robust Ryno benches can be weighted to up to 81kg, making them very difficult to pick up or mishandle. They can also be secured in place using our hidden floor fixing method (UK patent pending) to further reduce risks.

Our Ryno range has been designed to allow rainwater run-off and is totally waterproof, making products perfect for outdoor use.

We designed and manufactured bespoke fitted furniture in the bedrooms, installing them securely into a recessed portion of the wall.

The cabinetry was designed without doors to minimise ligature risks. All shelves and desk tops were reinforced with support panels, fixing them securely in place and creating a very strong and damage-resistant solution.

# CONTENTS

						DINING	BEDROOM	NEXT STEPS	INDEX
2	8	24	56	146		166	208	246	252
ABOUT US	CASE STUDIES	RYNO®	SOFT SEATING	LOUNGE					

**LEVELS OF SEVERITY**

<b>3</b>	●	●	Level 3: Extremely resilient, these products are designed for extremely challenging environments
●	<b>2</b>	●	Level 2: Safe and secure, these products are recommended for challenging environments
●	●	<b>1</b>	Level 1: Durable and dependable, these products are suitable for lower risk environments



# SAFE & SUSTAINABLE

Flame retardant	Strength tested	Environmental
<p>Flame retardant to contract level, all of our upholstery and fabrics meet BS 7176:2007 Source 0, 1 and 5 [Formerly BS5852 Source 0, 1 and 5].</p> <p>We also supply fabric and mattresses which meet Crib Source 7.</p> <p>This allows you to purchase with complete confidence knowing that all our products and fabrics are fully tried and tested.</p>	<p>All of our furniture is strength and stability tested to contract level.</p> <p>The picture below shows the Harrier sofa undergoing strength and stability testing, to BS EN 16139:2013 Level 2 (severe contract use).</p> <p>In this demanding test, seat and back durability is tested at least 100,000 times.</p>	<p>All the timber we use to build our furniture originates from responsibly managed forests.</p> <p>As supporters of good forest management, we use only suitably certified timber wherever possible.</p> <p>All our furniture is designed to last a lifetime, minimising waste and our Ryno® range is also 100% recyclable.</p> <p>Our commitment to these ideals is demonstrated in our ISO 14001:2015 award, our FSC® Chain of Custody certificate INT-COC-001353 and licence code FSC-C015370. In addition, we are certified under PEFC Chain of Custody certificate INT-PEFC/COC-001353.</p> <p>FSC certified products available upon request.</p>
		

# A CHOICE OF COLOURS BUT IT'S ALWAYS GREEN





# GUARANTEE & SERVICE



With our hassle-free White Glove delivery service, we place your furniture in individual rooms and take away all packaging, leaving you with furniture ready for use.

Over the past forty years we've built our business on providing the best products and service in our industry. We're proud of the strength of our products as well as the relationships we have with our customers.

## Giving you total peace of mind



Most of our furniture is guaranteed against **manufacturing faults for 7 years**



Our superbly durable **Ryno® range comes with a lifetime guarantee**

We pride ourselves on our aftercare service. Our support continues beyond the point of sale, going the extra mile to achieve complete customer satisfaction.



For exceptions, please see <https://uk.pineapplecontracts.com/guarantee>





# OUR NETWORK

Our growing global operation includes offices and partners around the world, ensuring that we can help customers wherever they are, whenever they need it

# VISIT OUR SHOWROOMS

Our UK showrooms in Kent and Yorkshire provide the opportunity to experience the comfort of our products for yourself as well as making side-by-side comparisons to ensure you make the right choice.

Feel free to bring your clients along too, have a coffee and look through materials and product options before making a decision.

Book your visit



UK showrooms in Kent and Yorkshire  
 Call +44(0)1622 237830 to book your visit

Can't make it?



If you can't make it to see us, we can always bring furniture samples to you.  
 Our demonstration models are an ideal way to help our customers make the right choice when it comes to furniture.

# THE FULL PACKAGE

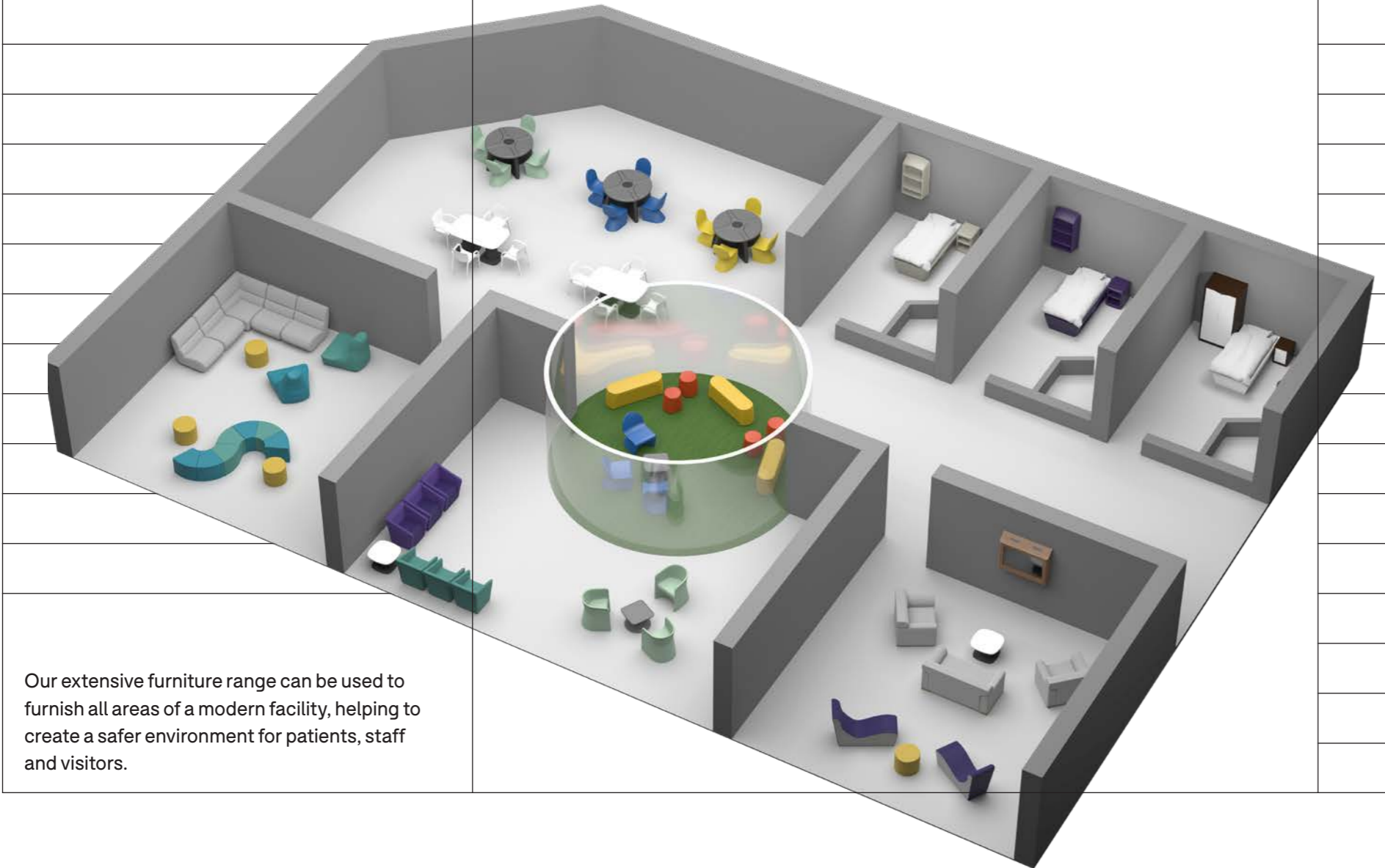

Our extensive furniture range can be used to furnish all areas of a modern facility, helping to create a safer environment for patients, staff and visitors.



**Dining area**  
Stress can be heightened during mealtimes, so our furniture is designed to minimise conflict as well as withstand outbreaks of challenging behaviour. Our Ryno® activity table weighs 140kg to prevent overturning and preserve safety.

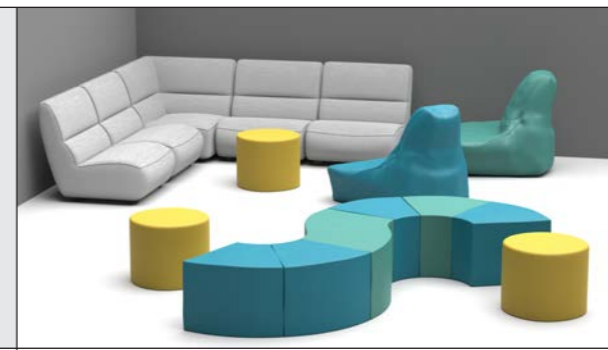

**Quiet lounge**  
Modular reinforced seating like our Snug Plus range can help to encourage social inclusion, while soft foam shapes and cosy beanbags provide a safe space for quiet reflection.

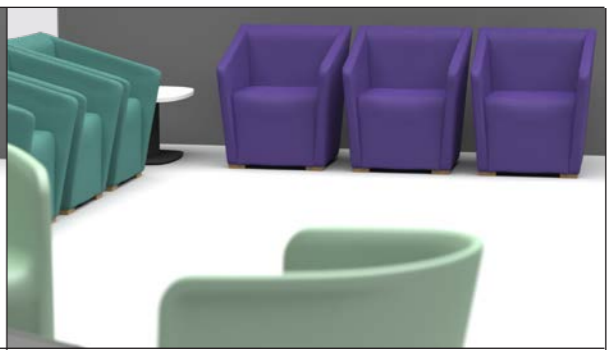

**Waiting area**  
Space efficient, easy-to-clean designs like Skye provide comfort for visitors while enabling staff to fulfil their duties more efficiently.



**Bedroom**  
Bedrooms are private spaces where round-the-clock observation may not be practical. Our safest bedroom ranges are designed to minimise ligature risks and reduce opportunities for damage.

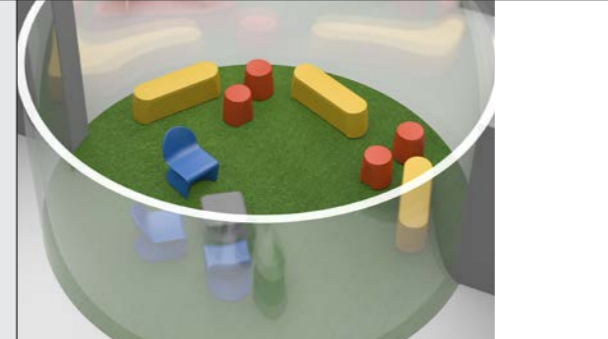

**Outdoor space**  
Products in our Ryno® range are totally water resistant and UV stabilised, and are heavily weighted as standard, making them a safe and durable option for outdoor spaces.



**TV lounge**  
Lockable wall and floor mounted TV cabinets with durable polycarbonate screens offer protection for equipment, and there is extensive choice in our broad range of sofas.

**RYNO<sup>®</sup>**

**COMBINING**

**EXTRAORDINARY**

**RESILIENCE WITH**

**ORGANIC STYLING**



# RYNO<sup>®</sup>

Ryno products are made to the highest standards and designed to withstand the harshest treatment, representing value for money over their lifetime.

All have been created with safety in mind, with all their characteristics resulting in safer settings for users and staff.

### Weatherproof

Ryno products are totally water-resistant and UV-stabilised, making them suitable for indoor and outdoor use in all weather



### Lifetime guarantee

All Ryno products are covered by a lifetime guarantee against manufacturing faults, providing additional peace of mind below



### Non-flammable

The entire Ryno range is fire-retardant, adding an extra level of safety essential in challenging environments



### Fixing

Using our unique hidden fastening methods, Ryno products can be secured to floors and/or walls, deterring weaponisation and reducing opportunities for concealment above

### Strength

Their one-piece construction enables Ryno products to withstand extreme treatment, with smooth curves distributing impact evenly throughout the product



### Hygienic

Ryno products are anti-bacterial and their water-resistant nature means they can easily be wiped clean, ready to be used again

*Ryno multi-purpose cleaning wipes are available upon request*



### Heavyweight

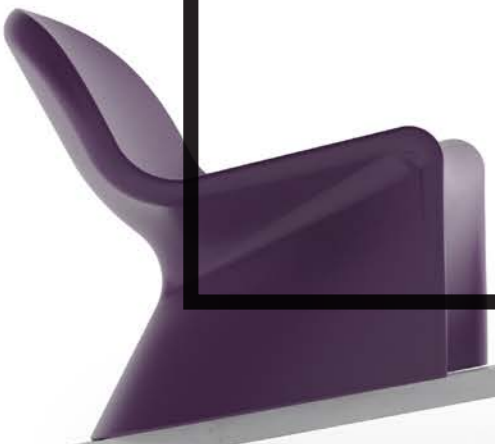

Ryno products can be heavily weighted to make them near-impossible to pick up or throw, to create safer environments

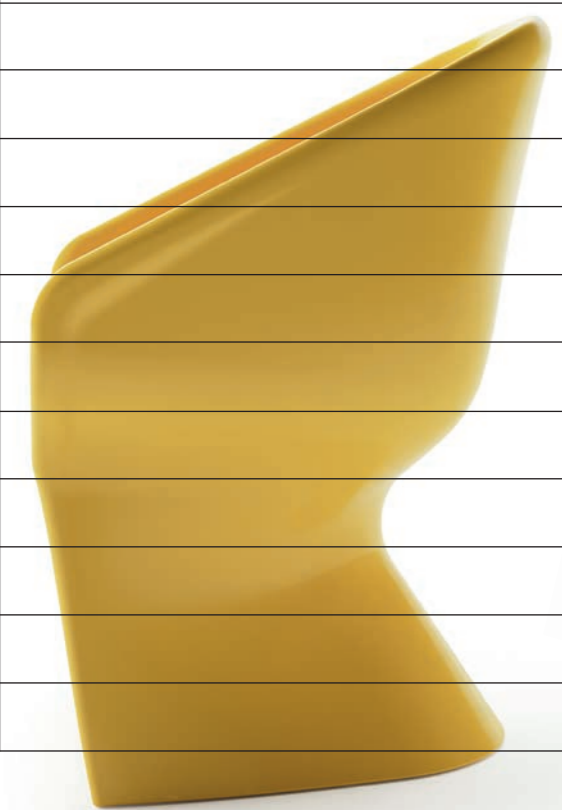

# RYNO<sup>®</sup> MATERIAL

Ryno products are manufactured from a unique polyethylene compound developed to create safe, durable products



	<p>A UV-stabilizing additive protects Ryno products against the damaging effects of the sun's rays, limiting color fading and brittleness when used for extended periods outdoors.</p>
	<p>Ryno products are UL94 HB compliant due to the inherently flame-retardant properties of our polymer.</p>
	<p>The addition of Silver Oxide inhibits bacterial growth, preserving high levels of hygiene and infection control throughout all Ryno products.</p>

# RYNO<sup>®</sup> COLOURS

A palette of therapeutic hues

Colour can play a key role in humanising healthcare environments, which is why we enlisted the help of SeymourPowell, one of the world's leading design and innovation consultancies, to assist us in selecting a palette of therapeutic hues.

Whether the aim is to create a soothing and reassuring space or provide inclusive stimulation, our unique colours can help to achieve it.



<p>seymourpowell</p>





# RYNO<sup>®</sup> TUB CHAIR



Seat static weight tested to  450KG



**Ryno tub chair**  
 1RYU-02  
 805H | 670W | 680D (mm)  
 Seat height: 430mm  
 Weight: 62kg

 Lifetime guarantee	 Weighted to deter misuse
 Fire retardant	 100% LDPE
 Weatherproof	 Floor fixed option

KEY FEATURES		OPTIONS
<ul style="list-style-type: none"> <li>→ Heavily weighted to 62kg to deter mishandling (other weight options available)</li> <li>→ Ergonomically designed armrests to assist standing and sitting</li> <li>→ Anti-microbial, wipe-clean material protects throughout the product</li> </ul>	<ul style="list-style-type: none"> <li>→ Water resistant, UV stabilised material makes items suitable for outdoor use</li> <li>→ Strength and stability tested for severe contract use (BS EN 16139:2013 Level 2). Exceeded the 200,000 cycles pass mark by a further 300,000 cycles</li> </ul>	<ul style="list-style-type: none"> <li>→ Floor fixing solution</li> <li>→ Linking bracket to connect chairs</li> <li>→ Lightweight model (18kg)</li> <li>→ Available in 10 versatile colours</li> </ul> <div style="display: flex; align-items: center;"> <div style="display: flex; gap: 5px;"> <span style="width: 15px; height: 15px; background-color: #808080; border-radius: 50%;"></span> <span style="width: 15px; height: 15px; background-color: #669999; border-radius: 50%;"></span> <span style="width: 15px; height: 15px; background-color: #663399; border-radius: 50%;"></span> <span style="width: 15px; height: 15px; background-color: #3399cc; border-radius: 50%;"></span> <span style="width: 15px; height: 15px; background-color: #cccccc; border-radius: 50%;"></span> </div> <span style="margin-left: 10px;">→ Core colours</span> </div> <div style="display: flex; gap: 5px; margin-top: 5px;"> <span style="width: 15px; height: 15px; background-color: #ff3333; border-radius: 50%;"></span> <span style="width: 15px; height: 15px; background-color: #99cc33; border-radius: 50%;"></span> <span style="width: 15px; height: 15px; background-color: #ffcc33; border-radius: 50%;"></span> <span style="width: 15px; height: 15px; background-color: #666666; border-radius: 50%;"></span> <span style="width: 15px; height: 15px; background-color: #333333; border-radius: 50%;"></span> </div>

*Wrap-around arms help those with reduced mobility*





# RYNO® CLUB CHAIR



Seat static weight tested to  450KG



**Ryno club chair**  
 1RYC-02  
 895H | 615W | 615D (mm)  
 Seat height: 450mm  
 Weight: 62kg

 Lifetime guarantee	 Weighted to deter misuse
 Fire retardant	 100% LDPE
 Weatherproof	 Floor fixed option

## KEY FEATURES

- Heavily weighted to 62kg as standard to deter misuse (other weight options available)
- Carefully considered curved design minimises ligature risks
- Strength and stability tested for severe contract use (BS EN 16139:2013 Level 2). Exceeded the 200,000 cycle pass mark by a further 300,000 cycles
- Anti-microbial, wipe-clean material protects throughout the product
- Water resistant, UV stabilised material makes items suitable for outdoor use

## OPTIONS

- Floor fixing solution
- Linking bracket to connect chairs
- Lightweight model (18kg)
- 10 vibrant shell colours

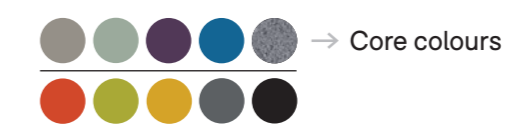

*Sloping arms designed to minimise ligature risks*





# RYNO<sup>®</sup> LOUNGE



Static weight tested to  450KG



**Ryno lounge chair**  
1RYL-02  
780H | 600W | 760D (mm)  
Seat height: 420mm  
Weight: 58kg



**Ryno coffee table**  
1RYF-02  
425H | 655W | 655D (mm)  
Weight: 56kg

 Lifetime guarantee	 Weighted to deter misuse
 Fire retardant	 100% LDPE
 Weatherproof	 Floor fixed option

## KEY FEATURES

- Heavily weighted as standard to deter misuse (other weight options available)
- Ergonomically designed to give excellent comfort
- Anti-microbial, wipe-clean material protects throughout the product

- Water resistant, UV stabilised material makes non-upholstered items suitable for outdoor use
- Chair static weight tested for bariatric use
- Strength and stability tested for severe contract use

## OPTIONS

- Upholstered seat and back pads
- Floor fixing solution
- Linking bracket to connect chairs
- Lightweight models
- 10 vibrant shell colours

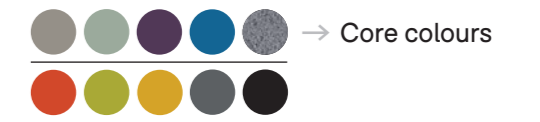

*One-piece design cannot be disassembled or weaponised*





# RYNO® DINING CHAIR





Seat static weight tested to 



**Ryno dining chair**  
 1RYD-02  
 880H | 500W | 620D (mm)  
 Seat height: 450mm  
 Weight: 56kg

 Lifetime guarantee	 Weighted to deter misuse
 Fire retardant	 100% LDPE
 Weatherproof	 Floor fixed option

KEY FEATURES	OPTIONS
<ul style="list-style-type: none"> <li>→ Heavily weighted to 56kg as standard to deter misuse (other weight options available)</li> <li>→ Ergonomically designed to give excellent comfort</li> <li>→ Anti-microbial, wipe-clean material protects throughout the product</li> </ul>	<ul style="list-style-type: none"> <li>→ Water resistant, UV stabilised material makes non-upholstered items suitable for outdoor use</li> <li>→ Strength and stability tested for severe contract use (BS EN 16139:2013 Level 2). Exceeded the 200,000 cycle pass mark by a further 300,000 cycles</li> </ul>
	<ul style="list-style-type: none"> <li>→ Upholstered seat and back pads</li> <li>→ Floor fixing solution</li> <li>→ Linking bracket to connect chairs</li> <li>→ Lightweight model (12kg)</li> <li>→ 10 vibrant shell colours</li> </ul>
	 → Core colours 

*One-piece design cannot be disassembled or weaponised*





# RYNO® CHILDREN



**Ryno children's chair**  
 1RYCD-01  
 750H | 420W | 525D (mm)  
 Seat height: 380mm  
 Weight: 30kg

-  Lifetime guarantee
-  Weighted to deter misuse
-  Fire retardant
-  100% LDPE
-  Weatherproof
-  Floor fixed option

KEY FEATURES		OPTIONS
<ul style="list-style-type: none"> <li>→ Heavily weighted to 30kg as standard to deter misuse (other weight options available)</li> <li>→ Ergonomically designed to give excellent comfort</li> <li>→ Anti-microbial, wipe-clean material protects throughout the product</li> </ul>	<ul style="list-style-type: none"> <li>→ Water resistant, UV stabilised material makes items suitable for outdoor use</li> <li>→ Designed for Sizemark 4 posture requirements (stature range 1330-1590mm)</li> </ul>	<ul style="list-style-type: none"> <li>→ Floor fixing solution</li> <li>→ Linking bracket to connect chairs</li> <li>→ Lightweight model (8kg)</li> <li>→ 10 vibrant shell colours</li> </ul> <div style="display: flex; align-items: center; margin-top: 5px;"> <div style="display: flex; gap: 5px;"> <span style="display: inline-block; width: 10px; height: 10px; background-color: #808080; border-radius: 50%;"></span> <span style="display: inline-block; width: 10px; height: 10px; background-color: #66b2b2; border-radius: 50%;"></span> <span style="display: inline-block; width: 10px; height: 10px; background-color: #4b0082; border-radius: 50%;"></span> <span style="display: inline-block; width: 10px; height: 10px; background-color: #0070c0; border-radius: 50%;"></span> <span style="display: inline-block; width: 10px; height: 10px; background-color: #a9a9a9; border-radius: 50%;"></span> </div> <span style="margin-left: 10px;">→ Core colours</span> </div> <div style="display: flex; gap: 5px; margin-top: 5px;"> <span style="display: inline-block; width: 10px; height: 10px; background-color: #ff4500; border-radius: 50%;"></span> <span style="display: inline-block; width: 10px; height: 10px; background-color: #90ee90; border-radius: 50%;"></span> <span style="display: inline-block; width: 10px; height: 10px; background-color: #ffd700; border-radius: 50%;"></span> <span style="display: inline-block; width: 10px; height: 10px; background-color: #696969; border-radius: 50%;"></span> <span style="display: inline-block; width: 10px; height: 10px; background-color: #000000; border-radius: 50%;"></span> </div>
		<p><i>Practical water-resistant, wipe-clean surface</i></p>





# RYNO® DINING TABLES













Static weight tested to  500KG



**Ryno dining table with moulded top**  
1RYDT-03  
750H | 1250W | 1250D  
Weight: 103kg



**Ryno activity table with flat laminate top (weighted to 140kg)**  
1RYAT-03  
750H | 1320W | 1320D (mm)  
Weight: 138kg

 Weighted to deter misuse	 Lifetime guarantee	 Fire retardant	 100% LDPE	 Weatherproof	 Floor fixed option	 Weighted to deter misuse	 Lifetime guarantee	 Fire retardant	 Floor fixed option
-----------------------------------------------------------------------------------------------------------------	-----------------------------------------------------------------------------------------------------------	-------------------------------------------------------------------------------------------------------	--------------------------------------------------------------------------------------------------	-----------------------------------------------------------------------------------------------------	-----------------------------------------------------------------------------------------------------------	-----------------------------------------------------------------------------------------------------------------	-----------------------------------------------------------------------------------------------------------	-------------------------------------------------------------------------------------------------------	-----------------------------------------------------------------------------------------------------------

## KEY FEATURES

- Heavily weighted to deter misuse (other weight options available)
- Cruciform base design prevents conflict and passing of contraband
- Anti-microbial, wipe-clean material protects throughout the product

- Moulded top table is water resistant and UV stabilised, making it suitable for outdoor use
- Strength and stability tested for severe contract use (BS EN 15372:2008 Level 3 6.4) to 300,000 cycles

## OPTIONS

- Floor fixing solution
- Lightweight models
- Choice of 4 colours for activity table top (Grey PU edging on all options)

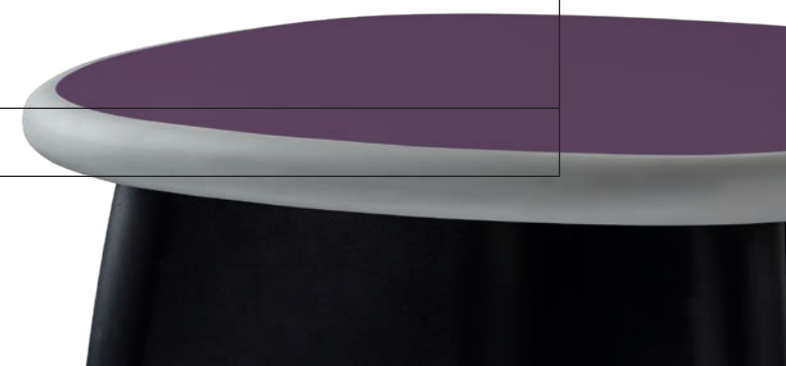





# RYNO® STOOL



Static weight tested to  450KG



**Ryno stool**  
 1RYS-02  
 470H | 445W | 395D (mm)  
 Seat height: 470mm  
 Weight: 49kg

 Lifetime guarantee	 Weighted to deter misuse
 Fire retardant	 100% LDPE
 Weatherproof	 Floor fixed option

KEY FEATURES		OPTIONS
<ul style="list-style-type: none"> <li>→ Heavily weighted to 49kg as standard to deter misuse (other weight options available)</li> <li>→ Ergonomically designed to prevent stacking and to deflect rainwater</li> <li>→ Durable polyethylene one-piece construction provides excellent strength and cannot be weaponised unlike conventional seating</li> </ul>	<ul style="list-style-type: none"> <li>→ Water resistant, UV stabilised material makes items suitable for outdoor use</li> <li>→ Anti-microbial, wipe-clean material protects throughout the product</li> <li>→ Strength and stability tested for severe contract use (BS EN 16139:2013 Level 2). Exceeded the 200,000 cycle pass mark by a further 300,000 cycles</li> </ul>	<ul style="list-style-type: none"> <li>→ Invisible floor fixing method (UK patent pending)</li> <li>→ Lightweight model (5kg)</li> <li>→ 10 vibrant shell colours</li> </ul> <div style="display: flex; align-items: center;"> <div style="display: flex; gap: 5px; margin-right: 10px;"> <div style="width: 15px; height: 15px; background-color: #808080; border-radius: 50%;"></div> <div style="width: 15px; height: 15px; background-color: #66CDAA; border-radius: 50%;"></div> <div style="width: 15px; height: 15px; background-color: #483D8B; border-radius: 50%;"></div> <div style="width: 15px; height: 15px; background-color: #1E90FF; border-radius: 50%;"></div> <div style="width: 15px; height: 15px; background-color: #A9A9A9; border-radius: 50%;"></div> </div> <span>→ Core colours</span> </div> <div style="display: flex; gap: 5px; margin-top: 5px;"> <div style="width: 15px; height: 15px; background-color: #FF4500; border-radius: 50%;"></div> <div style="width: 15px; height: 15px; background-color: #9ACD32; border-radius: 50%;"></div> <div style="width: 15px; height: 15px; background-color: #FFD700; border-radius: 50%;"></div> <div style="width: 15px; height: 15px; background-color: #696969; border-radius: 50%;"></div> <div style="width: 15px; height: 15px; background-color: #000000; border-radius: 50%;"></div> </div>
		<p><i>Provides peace of mind both indoors and out</i></p>





# RYNO<sup>®</sup> BENCH



Static weight tested to  900KG



**Ryno bench**  
 1RYN-02  
 470H | 1400W | 395D (mm)  
 Seat height: 470mm  
 Weight: 81kg

 Lifetime guarantee	 Weighted to deter misuse
 Fire retardant	 100% LDPE
 Weatherproof	 Floor fixed option

KEY FEATURES		OPTIONS
<ul style="list-style-type: none"> <li>→ Heavily weighted to 81kg as standard to deter misuse (other weight options available)</li> <li>→ Ergonomically designed to prevent stacking and to deflect rainwater</li> <li>→ Durable polyethylene one-piece construction provides excellent strength and cannot be weaponised unlike conventional seating</li> </ul>	<ul style="list-style-type: none"> <li>→ Water resistant, UV stabilised material makes items suitable for outdoor use</li> <li>→ Anti-microbial, wipe-clean material protects throughout the product</li> <li>→ Strength and stability tested for severe contract use (BS EN 16139:2013 Level 2). Exceeded the 200,000 cycle pass mark by a further 300,000 cycles</li> </ul>	<ul style="list-style-type: none"> <li>→ Invisible floor fixing method (UK patent pending)</li> <li>→ Lightweight model (15kg)</li> <li>→ 10 vibrant shell colours</li> </ul> <div style="display: flex; align-items: center;"> <div style="display: flex; gap: 5px; margin-right: 10px;"> <span style="display: inline-block; width: 15px; height: 15px; background-color: #808080; border-radius: 50%;"></span> <span style="display: inline-block; width: 15px; height: 15px; background-color: #66b2b2; border-radius: 50%;"></span> <span style="display: inline-block; width: 15px; height: 15px; background-color: #4b0082; border-radius: 50%;"></span> <span style="display: inline-block; width: 15px; height: 15px; background-color: #0070c0; border-radius: 50%;"></span> <span style="display: inline-block; width: 15px; height: 15px; background-color: #a9a9a9; border-radius: 50%;"></span> </div> <span>→ Core colours</span> </div> <div style="display: flex; gap: 5px; margin-top: 5px;"> <span style="display: inline-block; width: 15px; height: 15px; background-color: #ff0000; border-radius: 50%;"></span> <span style="display: inline-block; width: 15px; height: 15px; background-color: #90ee90; border-radius: 50%;"></span> <span style="display: inline-block; width: 15px; height: 15px; background-color: #ffff00; border-radius: 50%;"></span> <span style="display: inline-block; width: 15px; height: 15px; background-color: #404040; border-radius: 50%;"></span> <span style="display: inline-block; width: 15px; height: 15px; background-color: #000000; border-radius: 50%;"></span> </div>
		<p><i>Designed to minimise concealment opportunities</i></p>







# RYNO<sup>®</sup> BEDROOM

The products in this unique collection are manufactured in a single continuous piece.

This helps to create extremely durable products which, unlike traditional cabinetry, cannot be disassembled to be used as weapons.

The one-piece design is also eliminates gaps, making the products totally water-resistant and prevents the concealment of contraband.



Organic curves and ripple details evoke a natural feel, helping to nurture recovery below

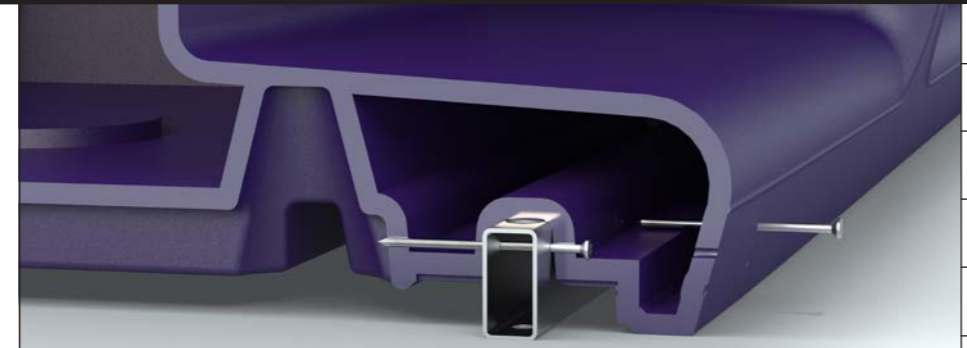

Innovative hidden floor-fixing options (UK patent pending) help to create safer spaces for patients and staff

Integrated clothes storage solution minimises ligature risks above



Optional infill panel minimises concealment opportunities when the bed is positioned against a wall left



# RYNO® BEDROOM



**Ryno Chest with 3 compartments**  
 1RYOC  
 735H | 698W | 507D (mm)  
 Weight: 24kg



**Ryno Desk**  
 Code: 1RYOD  
 735H | 698W | 507D (mm)  
 Weight: 20kg



**Ryno Bedside with 2 compartments**  
 1RYOB  
 595H | 400W | 380D (mm)  
 Weight: 13kg



**Ryno Wall shelf with 3 compartments**  
 1RYW  
 1200H | 699W | 313D (mm)  
 Weight: 20kg

KEY FEATURES	OPTIONS
→ One-piece design makes products water-resistant and prevents concealment of contraband	→ Invisible wall and floor fixing methods (UK patent pending)
→ Reduced-ligature design features	→ 10 vibrant shell colours
→ Safely rounded corners	→ Core colours
→ Organic textures help to create an environment that fosters recovery	

*Extremely durable one-piece construction*

- Lifetime guarantee
- Weatherproof
- Fire retardant
- Floor fixed
- Wall fixed





# RYNO<sup>®</sup> BED



**Ryno 3' bed with storage**  
1RYBS  
480H | 2100L | 1010W (mm)  
Weight: 103kg



**Ryno 3' bed**  
1RYB  
480H | 2100L | 1010W (mm)  
Weight: 110kg

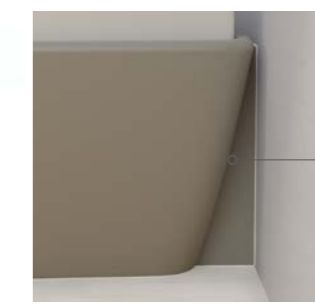

**Ryno bed inflill (right side)**  
1RYB-IR



**Ryno bed inflill (left side)**  
1RYB-IL

Optional inflill panel minimises concealment opportunities when the bed is positioned against a wall

**Scorpio anti-vandal mattress**  
1SOMR-001-C5  
125H | 2000L | 900W (mm)

International Registered  
Design No. DM/204506

Available fire retardant to Crib 5 and Crib 7  
Available 5" and 7" thick  
Available with optional security layer

## KEY FEATURES

- One-piece design creates a water-resistant, damage-resistant, anti-concealment bed
- Securely fixed to the floor (UK pat. pending)
- Safely rounded corners
- Organic textures help to create an environment that fosters recovery
- Tapered design maximises floor space and aids staff access

## OPTIONS

- Infill panels minimise concealment risks when positioned against a wall
- 10 vibrant shell colours (MOQ of 5 units for non-core colours)

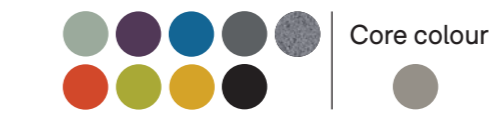

-  Lifetime guarantee
-  Weighted to deter misuse
-  Fire retardant
-  Weatherproof
-  Floor fixed option

*Extremely durable one-piece construction*







**SOFT SEATING**

**BLENDING DURABLE**

**SEATING WITH**

**COMFORTABLE**

**UPHOLSTERY**

# REINFORCED

# FOR PEACE OF MIND



All of our products are designed and tested for use in demanding environments, but for the most challenging spaces, our sofas on pages 61-101 have extra reinforcement for maximum strength and durability.

# STANDARD VS PLUS

<b>STANDARD</b>	Durable construction, perfect for low risk spaces	
	<p>Webbed back</p> <p>+ Reinforced seat adds strength &amp; durability</p>	<p>Cloth underside</p>
<b>PLUS</b>	Enhanced strength and safety features for challenging environments	
	<p>+ Reinforced back adds strength &amp; durability</p> <p>+ Reinforced seat adds strength &amp; durability</p>	<p>+ Reinforced underside adds strength &amp; reduces concealment opportunities</p>
	<p>→ Security screws are used (where accessible) to prevent tampering</p>	<p>→ No piping to reduce ligature risks</p> <p>→ No staples to reduce self-harm risks</p>





# DOMUS PLUS



Seat static weight tested to  200KG





**Domus Plus chair**  
1DUP1-100  
770H | 730W | 700D (mm)  
Seat height: 450mm  
Weight: 45kg



**Domus Plus 2-seater**  
1DUP2-100  
770H | 1360W | 700D (mm)  
Seat height: 450mm  
Weight: 85kg

*Also available without slots*

KEY FEATURES	OPTIONS	
→ Fully enclosed base to minimise concealment opportunities	→ Also available as standard model	
→ Immensely strong 25mm veneered plywood construction	→ Removable seat cushion for easy cleaning	
→ Seat platform rebated into back for additional strength	→ Available with or without slots	
→ Heavyweight to deter mishandling	→ Wide choice of water-resistant upholstery	
		





# PURL PLUS



Seat static weight tested to 200KG



**Purl Plus low back armchair**  
 1PULP1-400  
 870H | 700W | 780D (mm)  
 Seat Height: 480mm  
 Weight: 38kg



**Purl Plus high back armchair**  
 1PUHP1-400  
 1070H | 700W | 780D (mm)  
 Seat Height: 480mm  
 Weight: 41kg



**Purl Plus low back 2-seater**  
 1PULP2-400  
 870H | 1190W | 780D (mm)  
 Seat Height: 480mm  
 Weight: 52.5kg



**Purl Plus high back 2-seater**  
 1PUHP2-400  
 1070H | 1190W | 780D (mm)  
 Seat Height: 480mm  
 Weight: 56.5kg

*Standard reinforcement and fully enclosed base (Plus model)*

KEY FEATURES	OPTIONS
→ Standard reinforcement provides strength and durability	→ Also available as standard model
→ Wrap-around design of the seat back provides comfort and support	→ Available with chrome or natural wood feet
→ 480mm seat height designed to help those with reduced mobility	→ Wide choice of water-resistant upholstery
→ Fixed seat cushion to prevent misuse	







# SKYE PLUS



Seat static weight tested to 



**Skye Plus chair**  
1SKYP1-400  
825H | 735W | 785D (mm)  
Seat height 400mm  
Weight: 40kg



**Skye Plus 2-seater**  
1SKYP2-400  
825H | 1250W | 785D (mm)  
Seat height 400mm  
Weight: 58kg

KEY FEATURES
→ Strong plywood frame with additional reinforcement ensures maximum strength
→ Tapered base design to make standing easier
→ Compact design and small footprint maximises space
→ Heavyweight to deter mishandling

OPTIONS
→ Also available as standard model
→ Plinth base
→ Wide choice of water-resistant upholstery





*Optional plinth base prevents dust and dirt from gathering underneath*



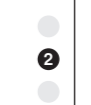

# TEMPO PLUS





Seat static weight tested to  200KG



**Tempo Plus chair**  
1TP1-400  
735H | 715W | 730D (mm)  
Seat height 400mm  
Weight: 38kg



**Tempo Plus 2-seater**  
1TP2-400  
735H | 1400W | 730D (mm)  
Seat height 400mm  
Weight: 76kg

KEY FEATURES	OPTIONS	
<ul style="list-style-type: none"> <li>→ Strong timber frame with additional reinforcement ensures maximum strength</li> <li>→ Enclosed base minimises concealment</li> <li>→ Fixed seat cushion prevents misuse</li> <li>→ Heavyweight to deter mishandling</li> </ul>	<ul style="list-style-type: none"> <li>→ Also available as standard model</li> <li>→ Removable seat cushion for easy cleaning</li> <li>→ Wide choice of water-resistant upholstery</li> </ul> 	
		<p><i>Comfortable back support with added reinforcement</i></p> 





# SIGMA PLUS



Seat static weight tested to  200KG





**Sigma Plus chair**  
1SIGP1-400  
800H | 800W | 708D (mm)  
Seat Height: 440mm  
Weight: 36kg

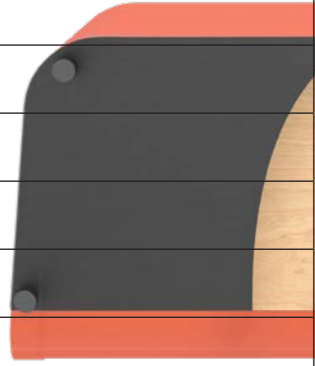

**Sigma Plus 2-seater**  
1SIGP2-400  
800H | 1350W | 708D (mm)  
Seat Height: 440mm  
Weight: 51kg

*Enclosed base with security fixings to prevent concealment*

KEY FEATURES	OPTIONS	
→ Wrap-around design of the seat back provides comfort and support	→ Also available as standard model	
→ Compact footprint helps you make the most of your available space	→ Wide choice of water-resistant upholstery	
→ Fixed seat cushion prevents misuse		
→ Heavyweight to deter mishandling		





# ZEN PLUS



Seat static weight tested to  500KG



**Zen Plus chair**  
1ZENP1-400  
1000H | 600W | 1485D (mm)  
Weight: 61.5kg



**Zen Plus duo chair**  
1ZENDP-400  
1000H | 600W | 990D (mm)  
Weight: 41.5kg



**Zen Plus duo footstool**  
1ZENDSP-400  
450H | 540W | 545D (mm)  
Weight: 23kg

KEY FEATURES	OPTIONS	<i>Perfect for areas of calm, rest and relaxation</i>
<ul style="list-style-type: none"> <li>→ Plywood reinforcement, including a fully enclosed base to prevent concealment</li> <li>→ Designed to prevent rapid standing motion, creating a safer and calmer environment</li> <li>→ Smoothly reclined shape prevents pressure points and provides exceptional comfort</li> <li>→ Weighted to deter mishandling</li> </ul>	<ul style="list-style-type: none"> <li>→ Also available as standard model</li> <li>→ Dual fabrics for added personalisation</li> <li>→ Wide choice of water-resistant upholstery</li> </ul> 	









# ZEN PLUS ROCKER



Seat static weight tested to  500KG



**Zen Plus Rocker**  
 1ZENRP1-400  
 1015H | 660W | 1115D (mm)  
 Weight: 59kg

KEY FEATURES	OPTIONS	
<ul style="list-style-type: none"> <li>→ Fluid rocking motion provides a source of focus and calm</li> <li>→ Smoothly reclined shape prevents pressure points and provides comfort</li> <li>→ Evenly distributed additional weight to prevent overturning</li> <li>→ Plywood reinforcement for added durability</li> <li>→ Security screws and inaccessible staples to prevent tampering</li> </ul>	<ul style="list-style-type: none"> <li>→ Dual fabrics for added personalisation</li> <li>→ Wide choice of water-resistant upholstery</li> </ul> 	<p><i>Provides a source of focus and calm</i></p>





# SNUG PLUS



Seat static weight tested to 



**Snug Plus chair**  
1SGP1-400  
890H | 940W | 1060D (mm)  
Seat height: 450mm  
Weight: 40kg



**Snug Plus footstool**  
1SGPS-400  
400H | 900W | 900D (mm)  
Weight: 26.5kg



**Snug Plus corner chair**  
1SGPC1-400  
890H | 1060W | 1060D (mm)  
Seat height: 450mm  
Weight: 53kg

KEY FEATURES	OPTIONS	
<ul style="list-style-type: none"> <li>→ Plywood reinforcement, including a fully enclosed base to prevent concealment</li> <li>→ Versatile modular design helps you make the most of your space</li> <li>→ Promotes social inclusion</li> <li>→ Low overall height provides clearer sight lines for staff</li> </ul>	<ul style="list-style-type: none"> <li>→ Also available as standard model</li> <li>→ Wide choice of water-resistant upholstery</li> </ul> 	<p><i>Combines sumptuous comfort with durable reinforcement</i></p>







# OHIO PLUS



Seat static weight tested to  200KG



**Ohio Plus chair**  
1OP1-400  
860H | 580W | 860D (mm)  
Seat height: 480mm  
Weight: 38kg





**Ohio Plus curved - wide front**  
1OPC1-500  
860H | 1030W | 860D (mm)  
Seat height: 480mm  
Weight: 25kg



**Ohio Plus curved - narrow front**  
1OPC1-400  
860H | 1030W | 860D (mm)  
Seat height: 480mm  
Weight: 27.5kg



**Ohio Plus coffee table**  
1OPF-400  
420H | 830W | 830D (mm)  
Weight: 34kg

KEY FEATURES	OPTIONS	
<ul style="list-style-type: none"> <li>→ Plywood reinforcement, including a fully enclosed base to prevent concealment</li> <li>→ Versatile modular design helps you make the most of your space</li> <li>→ Ski feet protect flooring and facilitate movement</li> </ul>	<ul style="list-style-type: none"> <li>→ Also available as standard model</li> <li>→ Linking bracket to connect items</li> <li>→ Plinth base</li> <li>→ Wide choice of water-resistant upholstery</li> </ul> 	<p><i>Optional plinth base prevents dust and dirt from gathering underneath</i></p>



# SNUG PLUS CONFIGURATIONS

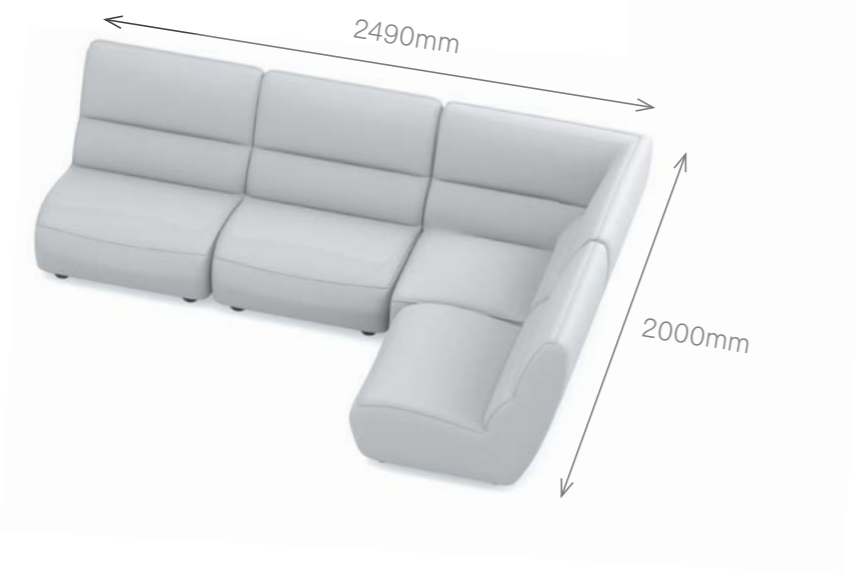
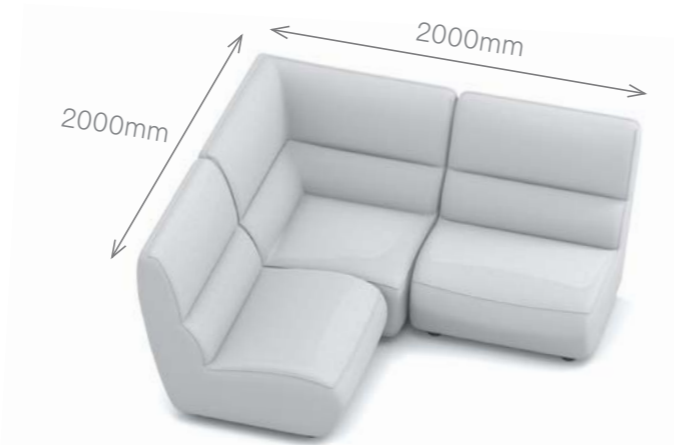
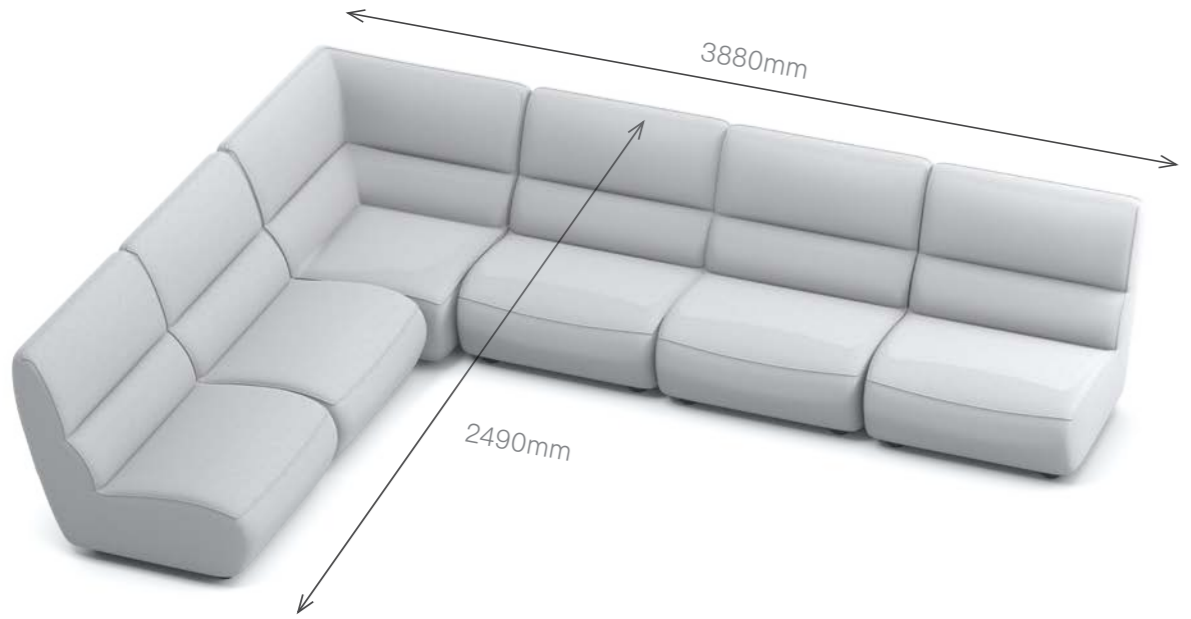

# OHIO PLUS CONFIGURATIONS

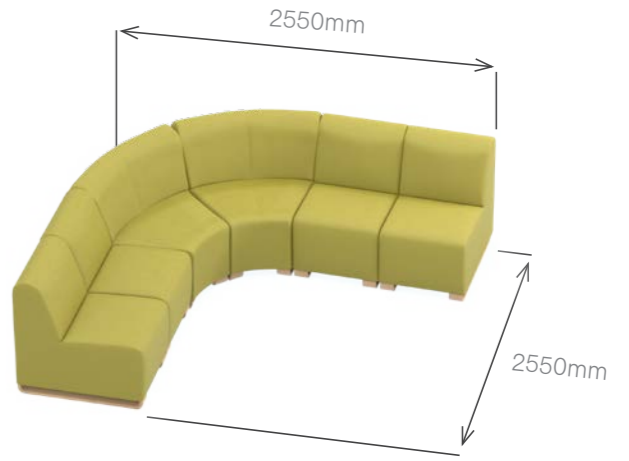
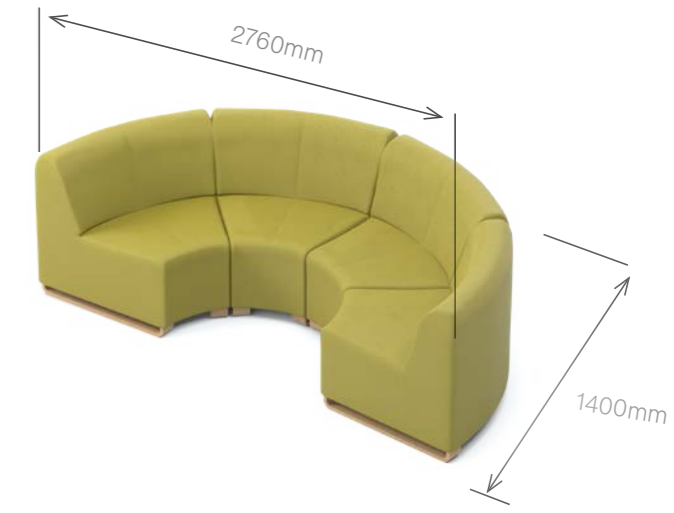









# MAGNA PLUS



Seat static weight tested to



**Magna Plus chair**  
1MA1-400  
780H | 970W | 860D (mm)  
Seat height: 420mm



**Magna Plus 3-seater**  
1MA3-400  
780H | 2010W | 860D (mm)  
Seat height: 420mm



**Magna Plus 2-seater**  
1MA2-400  
780H | 1500W | 860D (mm)  
Seat height: 420mm

KEY FEATURES	OPTIONS	
<ul style="list-style-type: none"> <li>→ Plywood reinforcement for added strength</li> <li>→ Fully enclosed base to prevent concealment</li> <li>→ Fixed seat and back cushions to prevent misuse</li> </ul>	<ul style="list-style-type: none"> <li>→ 'Zero depth' seams minimise concealment opportunities</li> <li>→ Clear-vision base to aid inspection</li> <li>→ Wide choice of water-resistant upholstery</li> </ul>	<p><i>Reinforced sofa with optional anti-concealment seams</i></p>





# QUADRA PLUS



Seat static weight tested to  200KG



**Quadra Plus chair**  
1QA1-400  
770H | 960W | 890D (mm)  
Seat height: 455mm



**Quadra Plus 3-seater**  
1QA3-400  
770H | 1940W | 890D (mm)  
Seat height: 455mm



**Quadra Plus 2-seater**  
1QA2-400  
770H | 1445W | 890D (mm)  
Seat height: 455mm

KEY FEATURES	OPTIONS
<ul style="list-style-type: none"> <li>→ Plywood reinforcement for added strength</li> <li>→ Fully enclosed base to prevent concealment</li> <li>→ Removable seat cushions for easy cleaning</li> </ul>	<ul style="list-style-type: none"> <li>→ Clear-vision base to aid inspection</li> <li>→ Wide choice of water-resistant upholstery</li> </ul> 

*Reinforced options makes this range as strong as you need it to be*

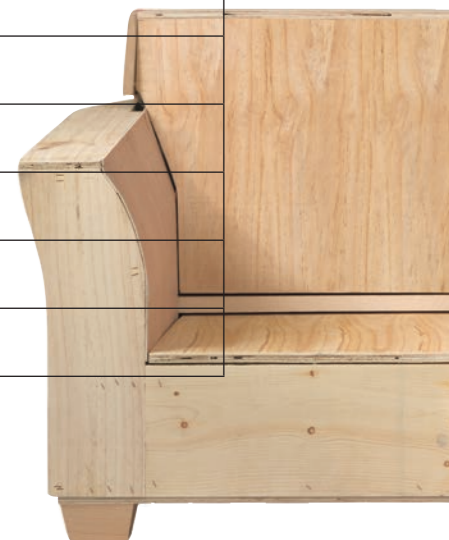





# HELIX PLUS



Seat static weight tested to  200KG



**Helix Plus chair**  
1HLX1-400  
930H | 1030W | 1000D (mm)  
Seat height: 450mm



**Helix Plus 3-seater**  
1HLX3-400  
930H | 2000W | 1000D (mm)  
Seat height: 450mm



**Helix Plus 2-seater**  
1HLX2-400  
930H | 1530W | 1000D (mm)  
Seat height: 450mm

KEY FEATURES	OPTIONS
<ul style="list-style-type: none"> <li>→ Wrap-around arm design provides comfort and support</li> <li>→ Loose seat and back cushions for ease of cleaning</li> </ul>	<ul style="list-style-type: none"> <li>→ Wide choice of water-resistant upholstery</li> </ul> 

*Reinforced options makes this range as strong as you need it to be*

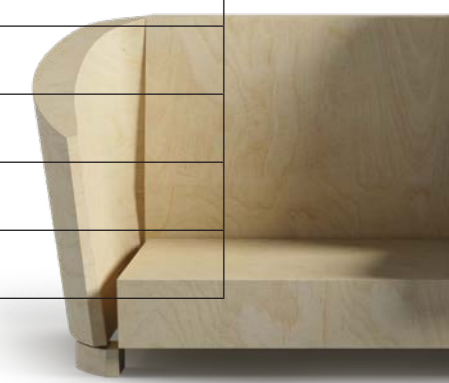





# ORR PLUS



Seat static weight tested to



**Orr Plus chair**  
1OR1-400  
850H | 710W | 870D (mm)  
Seat height: 440mm



**Orr Plus 3-seater**  
1OR3-400  
850H | 1770W | 870D (mm)  
Seat height: 440mm



**Orr Plus 2-seater**  
1OR2-400  
850H | 1240W | 870D (mm)  
Seat height: 440mm



**Orr Bariatric chair**  
1ORB1-400  
850H | 900W | 870D (mm)  
Seat height: 440mm

KEY FEATURES
→ Plywood reinforcement for added strength
→ Fully enclosed base to prevent concealment
→ Slim arm maximises seating capacity
→ Removable seat and back cushions for easy cleaning

OPTIONS
→ Clear-vision base to aid inspection
→ Wide choice of water-resistant upholstery



*Reinforced options makes this range as strong as you need it to be*







# ORR CORNER PLUS



Seat static weight tested to  500KG



**Orr Corner unit 2-seater left arm and 2-seater right arm**  
 1OC2L2R-400  
 850H | 2070W | 2070D (mm)  
 Seat height: 440mm



**Orr Corner unit 2-seater left arm and 3-seater right arm**  
 1OC2L3R-400  
 850H | 2590W | 2070D (mm)  
 Seat height: 440mm



**Orr Corner unit 3-seater left arm and 2-seater right arm**  
 1OC3L2R-400  
 850H | 2070W | 2590D (mm)  
 Seat height: 440mm



**Orr Corner unit 3-seater left arm and 3-seater right arm**  
 OC3L3R-400  
 850H | 2590W | 2590D (mm)  
 Seat height: 440mm

KEY FEATURES	OPTIONS	
→ Versatile layouts to suit your space	→ Clear-vision base to aid inspection	
→ Plywood reinforcement for added strength	→ Wide choice of water-resistant upholstery	
→ Fully enclosed base to prevent concealment		
→ Slim arm maximises seating capacity	<i>Reinforced options makes this range as strong as you need it to be</i>	
→ Removable seat and back cushions for easy cleaning		







# RUBUS PLUS

Seat static weight tested to 



**Rubus Plus chair**  
1RS1-400  
890H | 1170W | 940D (mm)  
Seat height: 445mm



**Rubus Plus 3-seater**  
1RS3-400  
890H | 2000W | 940D (mm)  
Seat height: 445mm



**Rubus Plus 2-seater**  
1RS2-400  
890H | 1720W | 940D (mm)  
Seat height: 445mm

KEY FEATURES	OPTIONS
<ul style="list-style-type: none"> <li>→ Plywood reinforcement for added strength</li> <li>→ Fully enclosed base to prevent concealment</li> <li>→ Removable seat cushions for easy cleaning</li> <li>→ Stylish chrome feet</li> </ul>	<ul style="list-style-type: none"> <li>→ Clear-vision base to aid inspection</li> <li>→ Wide choice of water-resistant upholstery</li> </ul> 

*Reinforced options makes this range as strong as you need it to be*

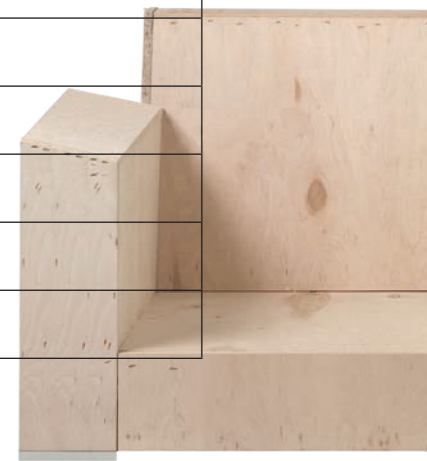





# HOBART PLUS



Seat static weight tested to  160KG



**Hobart Plus chair**  
1HO1-400  
1015H | 795W | 865D (mm)  
Seat height: 485mm



**Hobart Plus 3-seater**  
1HO3-400  
1015H | 1830W | 865D (mm)  
Seat height: 485mm



**Hobart Plus 2-Seater**  
1HO2-400  
1015H | 1315W | 865D (mm)  
Seat height: 485mm

KEY FEATURES	OPTIONS
<ul style="list-style-type: none"> <li>→ Plywood reinforcement for added strength</li> <li>→ Fully enclosed base to prevent concealment</li> <li>→ Wooden detail to arms</li> <li>→ Removable seat cushions for easy cleaning</li> </ul>	<ul style="list-style-type: none"> <li>→ Clear-vision base to aid inspection</li> <li>→ Wide choice of water-resistant upholstery</li> </ul> 

*Reinforced options makes this range as strong as you need it to be*

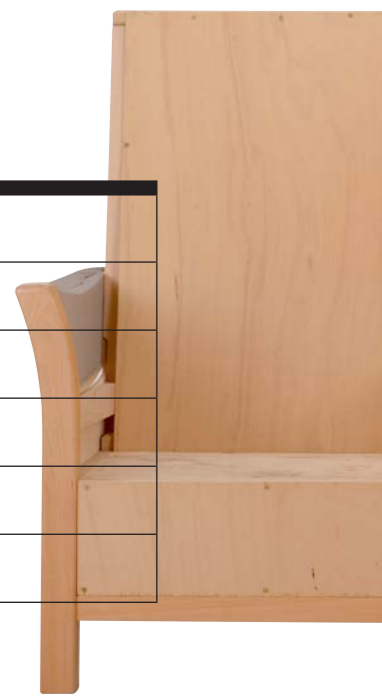





# HARRIER PLUS



Seat static weight tested to



**Harrier Plus chair**  
1HI1-400  
870H | 850W | 950D (mm)  
Seat height: 460mm



**Harrier Plus 3-seater**  
1HI3-400  
870H | 1920W | 950D (mm)  
Seat height: 460mm



**Harrier Plus 2-seater**  
1HI2-400  
870H | 1390W | 950D (mm)  
Seat height: 460mm

KEY FEATURES	OPTIONS	
<ul style="list-style-type: none"> <li>→ Plywood reinforcement for added strength</li> <li>→ Fully enclosed base to prevent concealment</li> <li>→ Scroll arm design with flared sides</li> <li>→ Removable seat cushions for easy cleaning</li> </ul>	<ul style="list-style-type: none"> <li>→ Clear-vision base to aid inspection</li> <li>→ Wide choice of water-resistant upholstery</li> </ul> 	<p><i>Reinforced options makes this range as strong as you need it to be</i></p>

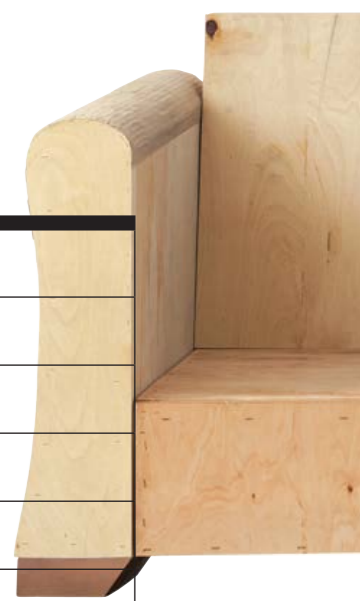



# OSPREY PLUS



Seat static weight tested to  200KG



**Osprey Plus chair**  
10Y1-400  
900H | 880W | 950D (mm)  
Seat height: 460mm



**Osprey Plus 3-seater**  
10Y3-400  
900H | 1950W | 950D (mm)  
Seat height: 460mm



**Osprey Plus 2-seater**  
10Y2-400  
900H | 1420W | 950D (mm)  
Seat height: 460mm



KEY FEATURES	OPTIONS	
<ul style="list-style-type: none"> <li>→ Plywood reinforcement for added strength</li> <li>→ Fully enclosed base to prevent concealment</li> <li>→ Scroll arm design with flared sides</li> <li>→ Removable seat and back cushions for easy cleaning</li> </ul>	<ul style="list-style-type: none"> <li>→ Clear-vision base to aid inspection</li> <li>→ Wide choice of water-resistant upholstery</li> </ul> 	<p><i>Reinforced options makes this range as strong as you need it to be</i></p>

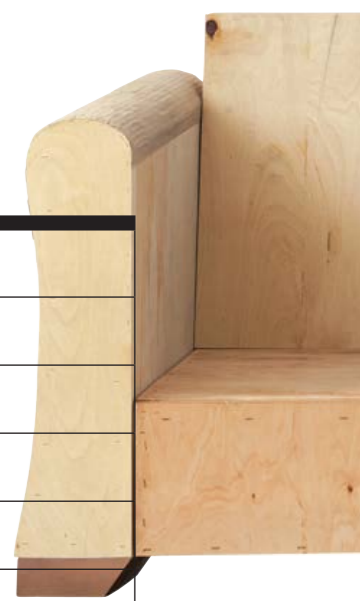





# AKESSEN PLUS



Seat static weight tested to  200KG



**Akessen Plus chair**  
1AN1-400  
900H | 890W | 930D (mm)  
Seat height: 450mm



**Akessen Plus 3-seater**  
1AN3-400  
900H | 1885W | 930D (mm)  
Seat height: 450mm



**Akessen Plus 2-seater**  
1AN2-400  
900H | 1335W | 930D (mm)  
Seat height: 450mm

KEY FEATURES	OPTIONS
<ul style="list-style-type: none"> <li>→ Plywood reinforcement for added strength</li> <li>→ Fully enclosed base to prevent concealment</li> <li>→ Removable seat and back cushions for easy cleaning</li> </ul>	<ul style="list-style-type: none"> <li>→ Clear-vision base to aid inspection</li> <li>→ Wide choice of water-resistant upholstery</li> </ul> 

*Reinforced options makes this range as strong as you need it to be*

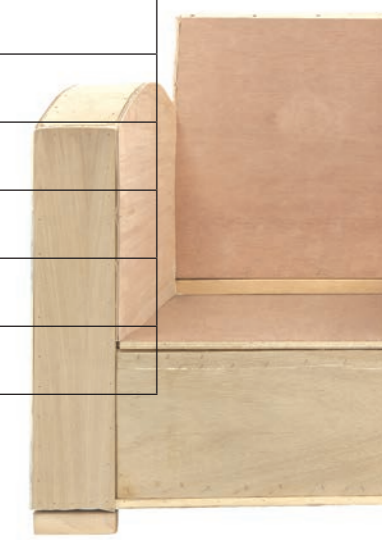





# ARUBA



Seat static weight tested to



**Aruba chair**  
1AA1-100  
880H | 960W | 920D (mm)  
Seat height: 490mm



**Aruba 3-seater**  
1AA3-100  
880H | 2020W | 920D (mm)  
Seat height: 490mm



**Aruba 2-seater**  
1AA2-100  
880H | 1490W | 920D (mm)  
Seat height: 490mm

KEY FEATURES	OPTIONS	
<ul style="list-style-type: none"> <li>→ Smooth rounded arms</li> <li>→ Removable seat and back cushions for easy cleaning</li> </ul>	<ul style="list-style-type: none"> <li>→ Available with Natural and Walnut feet</li> <li>→ Wide choice of water-resistant upholstery</li> </ul> 	<p><i>Available with reinforced seat platform for added durability</i></p>





# RONDO



Seat static weight tested to



**Rondo chair**  
 Level 1: 1RN1-100  
 Level 2: 1RN1-200  
 820H | 1015W | 800D (mm)  
 Seat height: 445mm



**Rondo 2.5-seater**  
 Level 1: 1RN25-100  
 Level 2: 1RN25-200  
 820H | 1830W | 800D (mm)  
 Seat height: 445mm

KEY FEATURES	OPTIONS	
<ul style="list-style-type: none"> <li>→ Smooth rounded arms</li> <li>→ Low overall height provides clearer sight lines for staff</li> <li>→ Stylish and strong solid metal ski leg</li> <li>→ Removable seat cushions for easy cleaning</li> </ul>	<p>→ Wide choice of water-resistant upholstery</p>	<p><i>Available with reinforced seat platform for added durability</i></p>



# LIBERTY

Our Liberty range is designed with inbuilt features that enhance hygiene, accessibility and inspection.



High floor clearance allows the use of hoists to manoeuvre less mobile patients

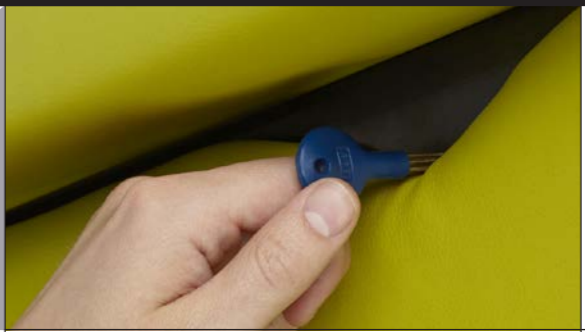
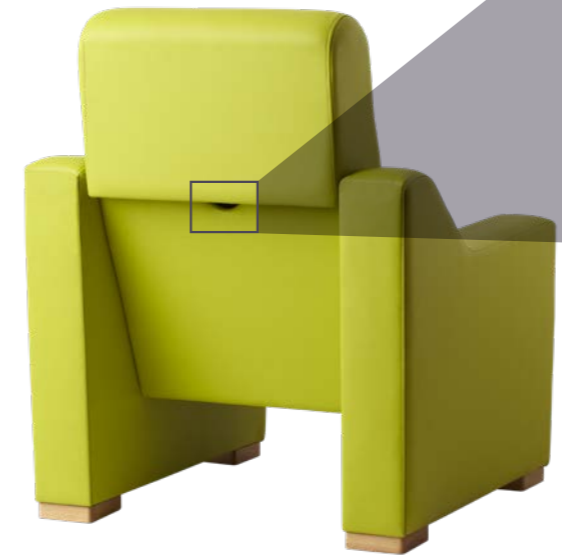

## REMOVABLE SEATS

Removable seats allowing for safe inspection and thorough cleaning, securely locked in place during use

**STEP 1**  
Insert key into back of seat and turn anti-clockwise to unlock



**STEP 2**  
Push and remove back



**STEP 3**  
Lift and remove seat



**STEP 4**  
Clean and inspect before replacing back and seat, locking securely with key



# LIBERTY



Seat static weight tested to  200KG



**Liberty chair**  
1LY1-300  
1040H | 850W | 900D (mm)  
Seat height: 480mm  
Weight: 73.5kg





**Liberty 3-seater**  
1LY3-300  
1040H | 2080W | 900D (mm)  
Seat height: 480mm  
Weight: 143.5kg



**Liberty 2-seater**  
1LY2-300  
1040H | 1540W | 900D (mm)  
Seat height: 480mm  
Weight: 110kg



KEY FEATURES	OPTIONS	
<ul style="list-style-type: none"> <li>→ Plywood reinforcement for strength</li> <li>→ Removable seat allows thorough inspection and cleaning</li> <li>→ Seat and back are securely locked in place during use</li> </ul>	<p>→ Wide choice of water-resistant upholstery</p> 	<p><i>Removable seat allows thorough inspection and cleaning</i></p> 



# REEF DE-ESCALATION





Seat static weight tested to  200KG



**Reef 3-seater**  
 1RF3-400  
 900H | 1885W | 930D (mm)  
 Seat height: 450mm



KEY FEATURES	OPTIONS	
<ul style="list-style-type: none"> <li>→ Armless design assists de-escalation practices and reduces likelihood of damage</li> <li>→ Full plywood reinforcement for extra strength and weight</li> </ul>	<ul style="list-style-type: none"> <li>→ Wide choice of water-resistant upholstery</li> </ul> 	<p><i>Armless design assists de-escalation</i></p> 



## DE-ESCALATION COUCH

# JAK

In situations where a patient is in severe distress and initial verbal de-escalation techniques have proven ineffective, physical intervention may be used as a last resort to prevent the patient causing harm to themselves and others.

During physical intervention staff will aim to restrict the patient's movements using the minimum force required, maintaining patient dignity. These interventions can be physically demanding, presenting risk of injury.

Through live service evaluations with clinical professionals, every angle of this couch has been optimised to support safer de-escalation practices for patients and staff alike.

### ANGLED DESIGN



- Outer seats angled at 33° to allow closer patient engagement, aiding verbal de-escalation
- Tapered footwell aides staff in safe de-escalation practices

### LOWERED CENTRAL SEAT

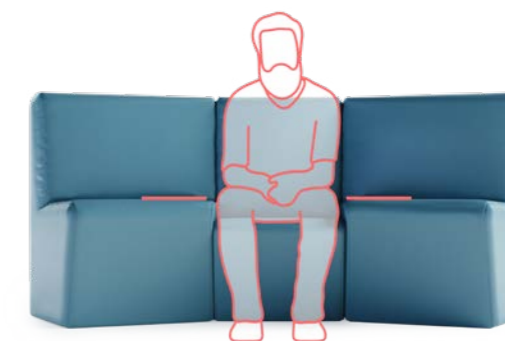

- Helps to control lateral movement
- Gives staff superior leg control

### UPRIGHT SEATING POSITION



- Preserves patient dignity
- Supports staff in de-escalation processes



Evidence-based design providing support when it's needed most.



Beneficial for all levels of intervention

Designed and developed in association with:

Andy Johnston Associates

Andy Johnston is a Clinical Director and independent mental health consultant with over 32 years of experience in mental health services including conflict resolution and physical intervention.

*"Staff body positions are supported throughout a seated intervention - great to see such a design"*

Physical intervention specialist





## JAK DE-ESCALATION COUCH



**JAK de-escalation couch**  
 1DES3-100  
 905H | 2020W | 875D (mm)  
 Mid. Seat Height: 400mm  
 Outer Seat Height: 465mm  
 Weight: 70kg

KEY FEATURES	OPTIONS	
<ul style="list-style-type: none"> <li>→ Outer seats angled inwards at 33° to provide staff back support</li> <li>→ Lowered central seat and tapered footwell aides staff in safe de-escalation practices</li> <li>→ Designed in conjunction with physical intervention specialists</li> </ul>	<ul style="list-style-type: none"> <li>→ Also available as a foam finished NG feeding couch (see page 117)</li> <li>→ Wide choice of water-resistant upholstery</li> </ul> 	<p><i>Designed to make physical intervention as safe and dignified as possible</i></p>





## ELLERN MEDE NG FEEDING COUCH



**NG feeding couch**  
 1NG3-100  
 905H | 2020W | 860D (mm)  
 Mid. Seat Height: 400mm  
 Outer Seat Height: 465mm  
 Weight: 106kg

KEY FEATURES	OPTIONS	
<ul style="list-style-type: none"> <li>→ Comfortable foam padding with internal reinforcement</li> <li>→ Hygienic water-resistant finish with no stitching or seams helps to maintain high standards of infection control</li> <li>→ Outer seats angled inwards at 33° to provide staff back support</li> <li>→ Lowered central seat and tapered footwell aides staff in safe restraint practices</li> <li>→ Designed in conjunction with eating disorder specialists</li> </ul>	<ul style="list-style-type: none"> <li>→ Also available as an upholstered couch (see page 115)</li> <li>→ Available in four versatile colours</li> </ul> 	<p><b>Designed and developed in association with:</b>                  Andy Johnston Associates &amp; Ellern Mede Specialist Eating Disorder Services. Ellern Mede are widely regarded as the UK's most specialist provider of intensive inpatient and outpatient treatment for children, adolescents and young adults.</p>
		<p><i>Hygienic water-resistant finish with no stitching or seams</i></p>





# BODEN



Static weight tested to  227KG



**Boden beanbag chair**  
1BOCHAIR1-400  
900H | 1000W | 1050D (mm)  
Weight: 7kg



**Boden beanbag**  
1BO1-400  
800H | 900W | 900D (mm)  
Weight: 7kg



**Boden extra large beanbag**  
1BO1-500  
560H | 1400Ø (mm)  
Weight: 14.5kg

## KEY FEATURES

- Double-stitched seams and non-accessible zips prevent tampering
- Flame retardant filling gives the beanbags their shape and comfort
- Internal seam lining provides an extra layer of protection

## OPTIONS

- Wide choice of water-resistant upholstery (we recommend a dark coloured wipe-clean vinyl)



*Flame-retardant filling and exterior*









# CONTESSA

Static weight tested to  227KG

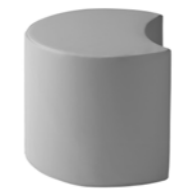
- 

**Contessa cube**  
1COFC-100  
460H | 575W | 575D (mm)  
Weight: 16.5kg
- 

**Contessa caterpillar**  
1COFCAT-100  
460H | ø 575 (mm)  
Weight: 12.5kg
- 

**Contessa drum**  
1COFD-100  
460H | 575 diameter (mm)  
Weight: 14.5kg
- 

**Contessa 90° curve**  
1COF90-100  
460H | 815W | 575D (mm)  
Weight: 14kg
- 

**Contessa cuboid**  
1COFCUB-100  
460H | 1150W | 575D (mm)  
Weight: 33kg
- 

**Contessa extra large drum**  
1COFD-300  
500H | ø 750 (mm)  
Weight: 23.5kg
- 

**Contessa extra large cube**  
1COFC-400  
500H | 600W | 600D (mm)  
Weight: 19.5kg
- 

**Contessa 45° curve**  
1COF45-100  
460H | 660W | 575D (mm)  
Weight: 13.5kg

KEY FEATURES	OPTIONS
<ul style="list-style-type: none"> <li>→ All foam construction with no internal frame for safety</li> <li>→ Zip heads removed and oversewn to prevent tampering</li> <li>→ Strong stitched seams</li> </ul>	<ul style="list-style-type: none"> <li>→ Wide choice of water-resistant upholstery (we recommend a dark coloured wipe-clean vinyl)</li> </ul> 

*CMHR foam provides a sturdy, fire-resistant core*

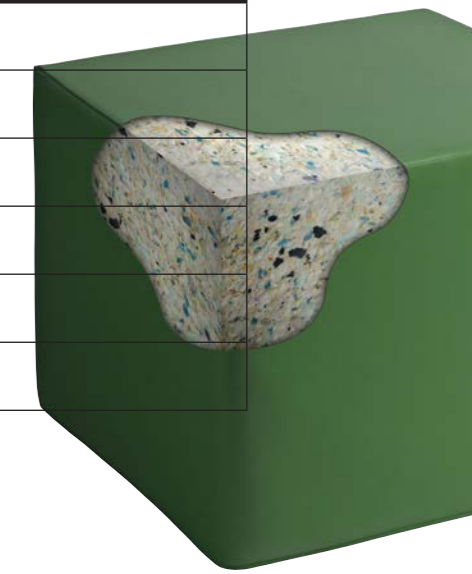





# CASCADE

# CASCADE PLUS

*Anti-vandal & totally water-resistant*



**Cascade low back chair**  
1CASL-100  
930H | 600W | 920D (mm)  
Seat height: 430mm



**Cascade Plus low back chair**  
1CSL-100  
930H | 600W | 920D (mm)  
Seat height: 430mm



**Cascade Plus low back calm chair**  
1CSCL-100  
930H | 670W | 1050D (mm)  
Seat height: 430mm



**Cascade Plus high back calm bench**  
1CSCBH-100  
1200H | 1800W | 1095D (mm)  
Seat height: 430mm



**Cascade low back calm chair**  
1CASCL-100  
930H | 670W | 1050D (mm)  
Seat height: 430mm



**Cascade Plus high back chair**  
1CSH-100  
1200H | 600W | 920D (mm)  
Seat height: 430mm



**Cascade Plus high back calm chair**  
1CSM-100  
1200H | 670W | 1100D (mm)  
Seat height: 430mm

KEY FEATURES - CASCADE
→ All-foam construction for safety
→ Strong stitched seams (please note, fluids can penetrate stitching)
→ Zip heads removed and oversewn to prevent tampering
→ Wedge at the front of the Calm chair to aid de-escalation

KEY FEATURES - CASCADE PLUS
→ All-foam construction for safety
→ Fully welded seams (no stitching or zips) for water resistance, hygiene and anti-tamper benefits
→ Strong anti-vandal, tear-resistant material
→ Wedge at the front of Calm chairs to aid de-escalation

OPTIONS
→ Cascade is available in a wide choice of water-resistant upholstery (we recommend a dark coloured wipe-clean vinyl)
→ Cascade Plus is available in four versatile colours





# ECLIPSE



**Eclipse low back chair**  
1ECL1-100  
870H | 800W | 680D (mm)  
Seat height 500mm



**Eclipse high back chair**  
1ECH1-100  
1080H | 800W | 680D (mm)  
Seat height 500mm



**Eclipse footstool**  
1ECS-100  
350H | 535W | 365D (mm)



**Eclipse low back 2-seater**  
1ECL2-100  
870H | 1300W | 680D (mm)  
Seat height 500mm



**Eclipse high back 2-seater**  
1ECH2-100  
1080H | 1300W | 680D (mm)  
Seat height 500mm

KEY FEATURES	OPTIONS	
→ Wings on all high backs for comfort and support	→ Removable seat cushion for easy cleaning	
→ Fixed seat and back cushions	→ Wide choice of water-resistant upholstery	
→ Tapered solid wood feet		





# LARSEN LOUNGE



**Larsen high back chair with arms**  
1LAH1-200  
1120H | 655W | 835D (mm)  
Seat height 500mm



**Larsen high back 2-seater with arms**  
1LAH2-200  
1120H | 1180W | 835D (mm)  
Seat height 500mm



**Larsen footstool**  
1LAS-100  
300H | 500W | 315D (mm)



**Larsen low back chair**  
1LAL1-100  
935H | 655W | 835D (mm)  
Seat height 500mm



**Larsen low back chair with arms**  
1LAL1-200  
935H | 655W | 835D (mm)  
Seat height 500mm



**Larsen low back 2-seater with arms**  
1LAL2-200  
935H | 1180W | 835D (mm)  
Seat height 500mm

Strength tested to 50 stone



**Larsen bariatric chair**  
1LB1-200  
1180H | 875W | 835D (mm)  
Seat height 500mm

## KEY FEATURES

- Stitched line in back to enhance comfort and appearance
- Loose seat cushion for easy cleaning
- Extra head support on high back chairs
- Matching dining chairs available (See page 185)

## OPTIONS

- Armpads for added comfort
- Wings for added head support
- Wide choice of water-resistant upholstery



*Optional wings for added head support*







# VISION LOUNGE



**Vision low back armchair**  
1VLL1-200  
880H | 605W | 715D (mm)  
Seat height 470mm



**Vision high back armchair**  
1VLH1-200  
1080H | 605W | 715D (mm)  
Seat height 470mm



**Vision low back chair without arms**  
1VLL1-100  
880H | 605W | 715D (mm)  
Seat height 470mm



**Vision footstool**  
1VLS-100  
310H | 480W | 340D (mm)  
Seat height 470mm

KEY FEATURES	OPTIONS	
→ Fixed seat cushion	→ Armpads for added comfort	
→ Stitch lines in back enhance comfort and appearance	→ Wide choice of water-resistant upholstery	
→ Matching dining chairs available (See page 187)		





# OSKAR



**Oskar low back chair without arms**  
 1OKL1-100  
 840H | 635W | 700D (mm)  
 Seat height: 430mm



**Oskar low back armchair**  
 1OKL1-200  
 840H | 635W | 700D (mm)  
 Seat height: 430mm



**Oskar high back chair without arms**  
 1OKH1-100  
 1015H | 635W | 700D (mm)  
 Seat height: 430mm



**Oskar high back armchair**  
 1OKH1-200  
 1015H | 635W | 700D (mm)  
 Seat height: 430mm

KEY FEATURES	OPTIONS	
<ul style="list-style-type: none"> <li>→ Strong bent plywood arm</li> <li>→ One-piece back and seat for strength and durability</li> <li>→ Classic Scandinavian styling</li> </ul>	<ul style="list-style-type: none"> <li>→ Available with filled arms</li> <li>→ Wide choice of water-resistant upholstery</li> </ul> 	<p><i>Strong one-piece laminate frame</i></p>





# VEE



Seat static weight tested to



**Vee armchair**  
1VE1-200  
830H | 565W | 640D (mm)  
Seat height 460mm  
Weight: 9.5kg



**Vee side chair**  
1VE1-100  
830H | 490W | 640D (mm)  
Seat height 460mm  
Weight: 8kg



**Vee Hijena armchair**  
1VH1-400  
830H | 565W | 640D (mm)  
Seat height 460mm  
Weight: 10kg

## KEY FEATURES

- One-piece back and seat for strength and durability
- Strong bent plywood frame
- Stackable for easy storage
- Hijena chair features a hygiene-gap to prevent dust and dirt from gathering

## OPTIONS

- Frame available in Natural and Walnut finish
- Wide choice of water-resistant upholstery



*Stylish and strong bent plywood frame*







# THOR



**Thor side chair**  
1TR1-300  
805H | 555W | 560D (mm)  
Seat height: 480mm



**Thor armchair**  
1TR1-400  
805H | 555W | 560D (mm)  
Seat height: 480mm

KEY FEATURES	OPTIONS	
<ul style="list-style-type: none"> <li>→ Strong bent plywood frame</li> <li>→ Hygiene-gap to prevent dirt and dust gathering</li> <li>→ Stackable for easy storage</li> </ul>	<p>→ Wide choice of water-resistant upholstery</p>	<p><i>Versatile stacking chair with bent plywood frame</i></p>

**Please note:** Minimum order quantity four chairs







# CHELtenham



**Cheltenham chair**  
1CH1-100  
1040H | 610W | 710D (mm)



**Cheltenham chair with armrests**  
1CH1-300  
1040H | 610W | 710D (mm)



**Cheltenham chair with filled sides**  
1CH1-200  
1040H | 610W | 710D (mm)

KEY FEATURES	OPTIONS	
<ul style="list-style-type: none"> <li>→ Extended arms provide additional hand grips to aid sitting and standing</li> <li>→ Stylish curved wood frame</li> <li>→ Loose seat cushion for easy cleaning</li> </ul>	<ul style="list-style-type: none"> <li>→ Frame available in Natural and German oak finish</li> <li>→ Wide choice of water-resistant upholstery</li> </ul> 	





# BOXER



**Boxer tub chair**  
 1BE1-100  
 815H | 770W | 700D (mm)  
 Seat height: 470mm  
 Weight: 20kg

KEY FEATURES	OPTIONS	
<ul style="list-style-type: none"> <li>→ Fixed seat cushion</li> <li>→ Wrap-around back support</li> <li>→ Deep seat cushion for added comfort</li> </ul>	→ Wide choice of water-resistant upholstery 	





# FIJI



**Fiji tub chair**  
 1FJ1-100  
 790H | 605W | 600D (mm)  
 Seat height: 455mm

KEY FEATURES	OPTIONS	
→ Compact space-saving design	→ Available in Natural and Walnut finish	
→ Sloping arm to aid sitting/standing	→ Wide choice of water-resistant upholstery	
→ Fixed seat and back cushions		
→ Deep seat cushion for added comfort		





# SLOANE



**Sloane chair**  
1SL1-100  
1050H | 820W | 800D (mm)  
Seat height: 480mm  
Weight: 43.5kg



**Sloane chair with optional headrest**  
1SL1-200  
1050H | 820W | 800D (mm)  
Seat height: 480mm  
Weight: 43.5kg

KEY FEATURES	OPTIONS	
→ Timeless high back design	→ Available in Natural and Walnut feet	
→ Wings for added head support	→ Wide choice of water-resistant upholstery	
→ Removable seat cushion for easy cleaning		





# SMILE



Seat static weight tested to  160KG



**Smile high back chair with stainless steel legs**  
 1SZH1-118  
 1175H | 820W | 720D (mm)  
 Seat height: 400mm  
 Weight: 40kg



**Smile high back chair with wooden legs**  
 1SZH1-158  
 1175H | 820W | 720D (mm)  
 Seat height: 400mm  
 Weight: 40kg

KEY FEATURES	OPTIONS	
→ Subtle wings provide comfort and privacy	→ Available with stainless steel, black powdercoated, or wooden legs	
→ Sweeping seat design acts as an integrated armrest	→ Wide choice of water-resistant upholstery	
→ Strong and elegant solid wood or metal legs		



**LOUNGE**

**FURNITURE IDEAL**

**FOR SAFE AND**

**STYLISH LIVING**

**SPACES**



# ROCK COFFEE TABLES



**Rock round coffee table**  
1RKf-600R  
420H | ø 600 (mm)



**Rock square coffee table**  
1RKf-600X600  
420H | 600W | 600D (mm)

KEY FEATURES		
→ Smooth chamfered edge protects top surface from damage		
→ Strong and durable solid birch frame		
→ White laminate top - heat and impact resistant		
→ Matching dining chairs and tables (see pages 169 and 195)		

*Cross-braced skis provide strength and manoeuvrability*





## NEENA SIDE TABLE



Neena side table  
 1NNA1-BIR  
 700H | 426W | 373D (mm)  
 Weight: 6kg

*Strong and durable moulded birch plywood construction*

KEY FEATURES		
→ Strong and durable moulded birch plywood construction		
→ Durable 5mm steel base with black powdercoated finish		
→ Lipped edge prevent items rolling off		





# OLAND COFFEE TABLES



**Oland square coffee table**  
1OLF-550X550  
425H | 550W | 550D (mm)



**Oland rectangular coffee table**  
1OLF-550X1000  
425H | 1000W | 550D (mm)



**Oland round coffee table**  
1OLF-026  
425H | ø 700 (mm)



**Oland square coffee table with shelf**  
1OLF-SHELF-550X550  
425H | 550W | 550D (mm)



**Oland rectangular coffee table with shelf**  
1OLF-002  
425H | 1000W | 550D (mm)



**Oland round coffee table with shelf**  
1OLF-SHELF-700  
425H | ø 700 (mm)

KEY FEATURES		
→ Natural wood effect laminate top – heat and impact resistant		
→ Rigid construction with corner braces		
→ Extra thick 60 x 60mm solid beech legs		
→ Matching dining tables (See page 205)		





# LICHFIELD COFFEE TABLES



**Lichfield round coffee table without shelf**  
1LIF-610  
415H | ø 610 (mm)



**Lichfield square coffee table without shelf**  
1LIF-550X550  
415H | 550W | 550D (mm)



**Lichfield rectangular coffee table without shelf**  
1LIF-550X1000  
415H | 1000W | 550D (mm)



**Lichfield round card table**  
1LIF-CARD-610  
610H | ø 610 (mm)



**Lichfield hall table**  
1LIF-SHELF-450X1070  
750H | 1070W | 450D (mm)



**Lichfield round coffee table with shelf**  
1LIF-SHELF-610  
415H | ø 610 (mm)



**Lichfield square coffee table with shelf**  
1LIF-SHELF-550X550  
415H | 550W | 550D (mm)



**Lichfield rectangular coffee table with shelf**  
1LIF-SHELF-550X1000  
415H | 1000W | 550D (mm)



**Lichfield square card table**  
1LIF-CARD-550X550  
610H | 550W | 550D (mm)



**Lichfield nest of tables**  
1LIF-NOT  
440-495H | 595W | 450D (mm)

KEY FEATURES		
→ Natural wood effect laminate top		
– heat and impact resistant		
→ Solid beech frame		





# HARBY COFFEE TABLES

2  
1

*Replaces our popular Hamble range*



**Harby square coffee table**  
1HYF-435x550x550  
435H | 550W | 550D (mm)



**Harby round coffee table**  
1HYF-435x610  
435H | ø 610 (mm)



**Harby rectangular coffee table**  
1HYF-435x550x1000  
435H | 550W | 1000D (mm)



**Harby Plus square coffee table**  
1HYPF-435x550x550  
435H | 550W | 550D (mm)  
Weight: 46kg



**Harby Plus round coffee table**  
1HYPF-435x610  
435H | ø 610 (mm)  
Weight: 30kg



**Harby Plus rectangular coffee table**  
1HYPF-435x550x1000  
435H | 550W | 1000D (mm)  
Weight: 87kg

KEY FEATURES - HARBY	KEY FEATURES - HARBY PLUS	
→ 18mm hickory melamine-faced carcass with 28mm thick tops	→ 18mm hickory melamine-faced carcass with 28mm thick tops	
	→ Heavily weighted to deter misuse	
	→ Enclosed base to prevent concealment	
	→ Security fixings to deter tampering	





# ACUMEN COFFEE TABLES



**Acumen square coffee table**  
1AUF-435x550x550  
435H | 550W | 550W (mm)



**Acumen round coffee table**  
1AUF-435x610  
435H | ø 610 (mm)



**Acumen rectangular coffee table**  
1AUF-435x550x1000  
435H | 550W | 1000W (mm)

KEY FEATURES	OPTIONS	
<ul style="list-style-type: none"> <li>→ Heavily weighted to deter misuse</li> <li>→ Enclosed base to prevent concealment</li> <li>→ Security fixings to deter tampering</li> <li>→ Smooth rounded corners for safety</li> <li>→ Matching lounge range (see page 163)</li> </ul>	<p>→ Available in Hickory and Walnut finish</p> <div style="display: flex; align-items: center; gap: 10px;"> <div style="width: 15px; height: 15px; background-color: #c08040; border-radius: 50%;"></div> <div style="width: 15px; height: 15px; background-color: #404040; border-radius: 50%;"></div> </div>	





# HARBY LOUNGE



*Replaces our popular Hamble range*



**Harby large bookcase**  
1HYE-200  
1800H | 760W | 300D (mm)



**Harby 2 door dresser**  
1HYJ-200  
1800H | 760W | 450D (mm)



**Harby tall storage cupboard**  
1HYG-100  
1800H | 875W | 370D (mm)



**Harby medium bookcase**  
1HYE-100  
1060H | 760W | 300D (mm)



**Harby 2 door cupboard**  
1HYG2-200  
740H | 760W | 450D (mm)



**Harby 2 door + 2 drawer sideboard**  
1HYG2-220  
740H | 760W | 450D (mm)



**Harby 3 door + 3 drawer sideboard**  
1HYG3-330  
740H | 1122W | 450D (mm)

## KEY FEATURES

- 28mm thick tops and 18mm hickory melamine-faced carcass
- Double thickness drawer fronts with 18mm back and sides and 10mm drawer bottoms result in very robust drawers

- Robust 160° opening hinges on all doors
- Durable metal drawer runners

## OPTIONS

- Locks to doors and drawers





# ACUMEN LOUNGE



Acumen large bookcase  
1AUE-200  
1800H | 850W | 300D (mm)



Acumen 2 door + 2 drawer dresser  
1AUJ22-100  
1800H | 946W | 450D (mm)



Acumen 2 door + 2 drawer sideboard  
1AUG22-100  
740H | 838W | 450D (mm)





Acumen 3 door + 3 drawer sideboard  
1AUG3-330  
740H | 1196W | 450D (mm)

## KEY FEATURES

- 28mm thick tops and 18mm hickory melamine-faced carcass
- Double thickness drawer fronts with 18mm back and sides and 8mm drawer bottoms result in very robust drawers
- Scalloped handles and piano hinges reduce ligature risks

- Heavy-duty metal drawer runners (rated to 45kg)
- Specially designed to minimise concealment areas (e.g. underside, between drawers)
- Security fixings to deter tampering
- Heavily weighted to deter misuse
- Smooth rounded corners for safety

## OPTIONS

- Locks to doors and drawers
- Available in:
  - Walnut (with White fronts) 
  - Hickory (with Grey fronts) 







# TV CABINETS



**Harby Plus wall mounted TV cabinet (32")**  
 1HYPN32-500  
 840H | 934W | 235D (mm)  
 Max. TV dimensions  
 545H | 830W | 155D (mm)  
 Visible screen size  
 475H | 760W (mm)



**Harby Plus wall mounted TV cabinet (42")**  
 1HYPN42-500  
 990H | 1174W | 235D (mm)  
 Max. TV dimensions  
 690H | 1070W | 155D (mm)  
 Visible screen size  
 620H | 1000W (mm)



**Harby Plus floor standing TV cabinet (42")**  
 1HYPN42-100  
 1631H | 1160W | 485D (mm)  
 Max. TV dimensions  
 690H | 1070W | 395D (mm)  
 Visible screen size  
 620H | 1000W (mm)



**Acumen wall fixed TV cabinet (32")**  
 1AUN32-500  
 876H | 922W | 235D (mm)  
 Max. TV dimensions  
 545H | 830W | 155D (mm)  
 Visible screen size  
 475H | 760W (mm)



**Acumen wall fixed TV cabinet (42")**  
 1AUN42-500  
 1021H | 1232W | 235D (mm)  
 Max. TV dimensions  
 690H | 1070W | 155D (mm)  
 Visible screen size  
 620H | 1000W (mm)



**Acumen floor standing TV cabinet (42")**  
 1AUN42-100  
 1631H | 1232W | 485D (mm)  
 Max. TV dimensions  
 690H | 1070W | 395D (mm)  
 Visible screen size  
 620H | 1000W (mm)

KEY FEATURES	OPTIONS	
<ul style="list-style-type: none"> <li>→ 8mm clear polycarbonate safety screen</li> <li>→ Securely lockable compartments</li> <li>→ Piano hinges to minimise ligature risks</li> <li>→ Secure ventilation to reduce overheating</li> </ul>	<ul style="list-style-type: none"> <li>→ Acumen products are available in Hickory and Walnut finish</li> </ul> 	



**DINING**

**TABLES AND CHAIRS**

**WELL SUITED FOR**

**CHALLENGING**

**ENVIRONMENTS**





# ROCK



Seat static weight tested to  317KG



**Rock chair**  
 1RK1-BIR-WHITE  
 810H | 520W | 520D (mm)  
 Seat height: 460mm  
 Weight: 7.5kg

KEY FEATURES		
→ Cross-braced skis provide additional strength and manoeuvrability		
→ One-piece seat with wipe-clean laminate surface	<i>One-piece seat with wipe-clean surface</i>	
→ Strong and durable solid birch frame		
→ Matching coffee and dining tables (see pages 149 and 195)		
		





# FUSION



**Fusion chair**  
 1FU1-400A  
 900H | 440W | 700D (mm)  
 Seat height: 490mm  
 Weight: 45kg

KEY FEATURES	OPTIONS	
<ul style="list-style-type: none"> <li>→ Heavily weighted to 45kg to increase stability and deter misuse</li> <li>→ Fully upholstered with stitched seams and security fixings (no piping or staples)</li> <li>→ Solid beech skis for manoeuvrability</li> <li>→ Solid 18mm thick plywood seat and base panels</li> </ul>	<ul style="list-style-type: none"> <li>→ Wide choice of water-resistant upholstery</li> </ul> 	<p><i>Heavily weighted to 45kg to deter misuse</i></p>





Espresso.....1.85  
 Americano.....2.50  
 Capuccino.....2.80  
 Latte Machiatto.....2.50  
 Earl Grey.....1.50  
 English breakfast.....1.80  
 Rooibos.....1.80  
 Cold Matcha.....2.85  
 Soft Drinks.....2.00  
 Draft Beer.....4.50  
 Wine(Glass).....3.50  
 Sandwich.....6.50

# TOUCH



Seat static weight tested to  200KG





**Touch chair**  
 1TU1-010  
 820H | 460W | 560D (mm)  
 Seat height: 410mm  
 Weight: 8kg



**Touch barstool in Oyster Grey**  
 1TUS-006-OG  
 1090H | 460W | 560D (mm)  
 Seat height: 680mm  
 Weight: 8.5kg



**Storage trolley**  
 (Capacity 30 chairs)

KEY FEATURES	OPTIONS	
→ Multi-purpose stacking chair (stacks up to 12 chairs)	→ Available with wheeled storage trolley (capacity 30 chairs)	
→ Durable polypropylene shell with handle cut-out for lifting	→ Upholstered seat pad	
→ Solid chromed steel rod frame	→ Choose from 5 vibrant shell colours (barstool available in Grey only)	
→ One-piece seat with hygienic wipe-clean surface		







# XEON



Seat static weight tested to  200KG



**Xeon chair**  
1EN1  
820H | 570W | 460D (mm)  
Seat height: 450mm  
Weight: 6kg

KEY FEATURES	OPTIONS
<ul style="list-style-type: none"> <li>→ Lightweight but strong multi-purpose stacking chair</li> <li>→ One-piece seat with hygienic wipe-clean surface</li> <li>→ UV stabilised water-resistant material is suitable for indoor and outdoor use</li> <li>→ Fire retardant to Crib Source 5</li> </ul>	<p>→ Available in White and Red</p> <p> </p>









# NERO



Seat static weight tested to  200KG



**Nero chair**  
 1NO1-200  
 820H | 570W | 460D (mm)  
 Weight: 4kg

KEY FEATURES	OPTIONS	
<ul style="list-style-type: none"> <li>→ Multi-purpose stacking chair</li> <li>→ One-piece seat with hygienic wipe-clean surface</li> <li>→ UV stabilised water-resistant material is suitable for indoor and outdoor use</li> <li>→ Polypropylene reinforced with glass fibre construction</li> </ul>	<p>→ Available in Orange, Blue and Black</p> <div style="display: flex; gap: 10px;"> <span style="width: 15px; height: 15px; background-color: orange; border-radius: 50%;"></span> <span style="width: 15px; height: 15px; background-color: lightblue; border-radius: 50%;"></span> <span style="width: 15px; height: 15px; background-color: black; border-radius: 50%;"></span> </div>	





# NEXUS



Seat static weight tested to  160KG



**Nexus dining side chair with polished wooden seat**  
1NS1-001  
875H | 480W | 540D (mm)  
Seat height: 450mm



**Nexus dining side chair with upholstered seat**  
1NS1-100  
875H | 480W | 540D (mm)  
Seat height: 480mm



**Nexus dining side chair with upholstered back and seat**  
1NS1-300  
875H | 480W | 540D (mm)  
Seat Height: 480mm



**Nexus dining armchair with polished wooden seat**  
1NS1-200  
875H | 530W | 540D (mm)  
Seat height: 450mm



**Nexus dining armchair with upholstered seat**  
1NS1-200A  
875H | 530W | 540D (mm)  
Seat height: 480mm



**Nexus dining armchair upholstered back and seat**  
1NS1-400  
875H | 530W | 540D (mm)  
Seat height: 480mm

KEY FEATURES
→ Strong one-piece wrap around arm
→ Braced legs for additional stability
→ Corner braces under seat provide additional strength
→ Solid beech construction

OPTIONS
→ Skis to protect flooring and facilitate movement
→ Available in Natural and Walnut finish
→ Wide choice of water-resistant upholstery



Please note: Minimum order quantity four chairs

*Braced legs for additional stability and durability*





# TROY



Seat static weight tested to  200KG



**Troy chair**  
1TY1  
860H | 450W | 500D (mm)  
Weight: 7kg



**Troy chair with upholstered seat**  
1TY1-100A  
860H | 450W | 500D (mm)  
Weight: 7kg

KEY FEATURES	OPTIONS
<ul style="list-style-type: none"> <li>→ Multi-purpose stacking chair</li> <li>→ Strong one-piece seat and back</li> <li>→ Durable welded frame with graphite finish</li> </ul>	<ul style="list-style-type: none"> <li>→ Wide choice of water-resistant upholstery</li> </ul> 







# BOSS



Seat static weight tested to  317KG



**Boss side chair with wooden seat**  
 1BS1-001  
 880H | 460W | 550D (mm)  
 Seat height: 460mm  
 Weight: 9.5kg





**Boss side chair with padded seat**  
 1BS1-100  
 880H | 460W | 550D (mm)  
 Seat height: 525mm  
 Weight: 10kg



**Boss armchair with wooden seat**  
 1BS1-002  
 880H | 545W | 550D (mm)  
 Seat height: 460mm  
 Weight: 10.5kg



**Boss armchair with padded seat**  
 1BS1-200  
 880H | 545W | 550D (mm)  
 Seat height: 525mm  
 Weight: 11kg

KEY FEATURES	OPTIONS	
<ul style="list-style-type: none"> <li>→ Solid beech construction with 25mm thick seat</li> <li>→ Curved braces between back and seat provide additional strength</li> <li>→ Corner braces under seat and cross bars used between legs for maximum strength</li> </ul>	<ul style="list-style-type: none"> <li>→ Skis to protect flooring and facilitate movement</li> <li>→ Undershelf to minimise ligature risks</li> <li>→ Wide choice of water-resistant upholstery</li> </ul> 	

*Optional skis for ease of movement*





# LARSEN DINING



Seat static weight tested to  160KG



**Larsen Dining side chair**  
 1LD1-300  
 860H | 480W | 580D (mm)  
 Seat height: 480mm



**Larsen Dining armchair**  
 1LD1-400  
 860H | 590W | 580D (mm)  
 Seat height: 480mm

KEY FEATURES	OPTIONS
<ul style="list-style-type: none"> <li>→ Stackable for easy storage</li> <li>→ Curved stylish solid beech frame</li> <li>→ Corner braces under seat provide added strength</li> <li>→ Double thickness arms enhance strength</li> <li>→ Additional strength provided by bracing</li> </ul>	<ul style="list-style-type: none"> <li>→ Matching lounge chairs available (see page 127)</li> <li>→ Wide choice of water-resistant upholstery</li> </ul> 







# VISION DINING



Seat static weight tested to 



**Vision Dining side chair**  
1VN1-100  
800H | 470W | 560D (mm)  
Seat height: 505mm



**Vision Dining side chair upholstered back and seat**  
1VN1-300  
800H | 470W | 560D (mm)  
Seat height: 505mm



**Vision Dining armchair**  
1VN1-200  
800H | 595W | 560D (mm)  
Seat height: 505mm



**Vision Dining armchair upholstered back and seat**  
1VN1-400  
800H | 595W | 560D (mm)  
Seat height: 505mm

KEY FEATURES	OPTIONS
<ul style="list-style-type: none"> <li>→ Stackable for easy storage</li> <li>→ Additional strength provided by bracing</li> <li>→ Matching lounge chairs available (see page 129)</li> </ul>	<ul style="list-style-type: none"> <li>→ Wide choice of water-resistant upholstery</li> </ul> 







# UPPSALA



Seat static weight tested to  160KG



**Uppsala slatback side chair**  
1UP1-100  
1000H | 520W | 600D (mm)  
Seat height: 475mm



**Uppsala upholstered back side chair**  
1UP1-300  
1000H | 520W | 600D (mm)  
Seat height: 475mm



**Uppsala slatback armchair**  
1UP1-200  
1000H | 520W | 600D (mm)  
Seat height: 475mm



**Uppsala upholstered back armchair**  
1UP1-400  
1000H | 520W | 600D (mm)  
Seat height: 475mm

KEY FEATURES	OPTIONS	
<ul style="list-style-type: none"> <li>→ Stackable for easy storage</li> <li>→ Strong one-piece bent plywood frame</li> </ul>	<ul style="list-style-type: none"> <li>→ Wide choice of water-resistant upholstery</li> </ul> 	





# CUMULUS PLUS

Featuring a solid steel base plate and thick steel pedestal, this table range is heavyweight, strong and stable.



High-pressure laminate top fixed to durable steel fixing plate with security screws left

Heavyweight solid steel base plate and pedestal for safety and stability left



Table tops available in White, Anthracite and Hickory

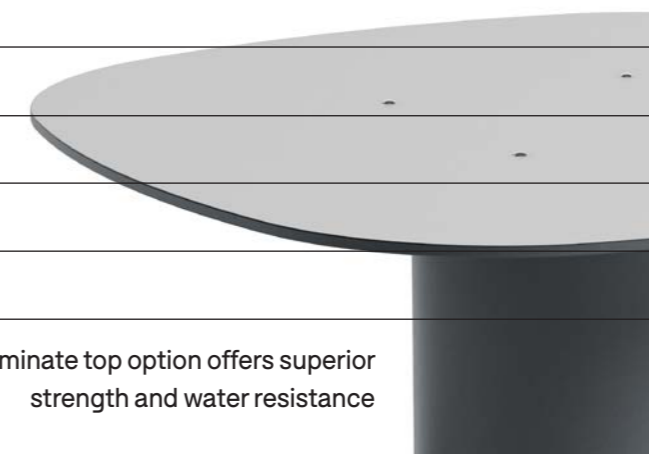

Solid grade laminate top option offers superior strength and water resistance



Lower height tables available for children





# CUMULUS PLUS

Static weight tested to 500KG



**Cumulus Plus coffee table**  
1CSPF-7070  
420H | 700W | 700D (mm)  
Weight: 60kg



**Cumulus Plus 700 x 700 square dining table**  
1CSPT-7070  
740H | 700W | 700D (mm)  
Weight: 66kg

**Cumulus Plus 900 x 900 square dining table**  
1CSPT-9090  
740H | 900W | 900D (mm)  
Weight: 71kg

**Cumulus Plus 1200 x 1200 square dining table**  
1CSPT-1212  
740H | 1200W | 1200D (mm)  
Weight: 92kg



**Cumulus Plus 1500 x 900 rectangular dining table**  
1CSPT-1590  
740H | 1500W | 900D (mm)  
Weight: 123kg

**Cumulus Plus 1800 x 900 rectangular dining table**  
1CSPT-1890  
740H | 1800W | 900D (mm)  
Weight: 127kg

KEY FEATURES	OPTIONS	
<ul style="list-style-type: none"> <li>→ Heat and impact resistant laminate top</li> <li>→ Solid steel base plate provides strength and stability</li> <li>→ 300mm diameter steel pedestal for added strength</li> <li>→ Heavily weighted to deter misuse</li> <li>→ Suitable for wheelchair users</li> </ul>	<ul style="list-style-type: none"> <li>→ Table tops available in White, Anthracite and Hickory </li> <li>→ Solid grade laminate top for superior strength and water resistance</li> <li>→ Lower risk Cumulus tables available</li> <li>→ Lower height (640mm high) tables available for children</li> </ul>	<p><i>Also available - Cumulus tables</i></p>





# ROCK



Static weight tested to  500KG



Code: 1RKT-900R  
740H | ø 900 (mm)

Code: 1RKT-1200R  
740H | ø 1200 (mm)



**Rock square dining table**  
Code: 1RKT-9090  
740H | 900W | 900D (mm)

Code: 1RKT-1212  
740H | 1200W | 1200D (mm)



**Rock rectangular dining table**  
Code: 1RKT-1290  
740H | 900W | 1200D (mm)

Code: 1RKT-1590  
740H | 900W | 1500D (mm)

Code: 1RKT-1890  
740H | 900W | 1800D (mm)

Code: 1RKT-1200X2400  
740H | 1200W | 2400D (mm)

KEY FEATURES		
→ Smooth chamfered edge protects top surface from damage		 <p><i>Chamfered edge protects the top surface from damage</i></p>
→ Strong and durable solid birch frame		
→ White laminate top - heat and impact resistant		
→ Matching coffee tables and chairs (see pages 149 and 169)		





# CANTERBURY PLUS



**Canterbury Plus 915 x 915 square dining table**  
1CBPT-915X915  
740H | 915W | 915D (mm)



**Canterbury Plus 915 x 1980 rectangular dining table**  
1CBT-915X1980  
740H | 915W | 1980D (mm)  
Weight: 59.5kg

**Canterbury Plus 1220 x 1980 rectangular dining table**  
1CBPT-1220X1980  
740H | 1220W | 1980D (mm)  
Weight: 70.8kg



**Canterbury Plus ø 1065 round dining table**  
1CBPT-1065  
740H | ø 1065 (mm)

**Canterbury Plus ø 1220 round dining table**  
1CBPT-1220  
740H | ø 1220 (mm)  
Weight: 35.3kg

**Canterbury Plus 915 x 2135 rectangular dining table**  
1CBT-915X2135  
740H | 915W | 2135D (mm)  
Weight: 62.2kg

**Canterbury Plus 1220 x 2135 rectangular dining table**  
1CBPT-1220X2135  
740H | 1220W | 2135D (mm)  
Weight: 71.2kg

**Canterbury Plus 915 x 2440 rectangular dining table**  
1CBPT-915X2440  
740H | 915W | 2440D (mm)  
Weight: 68.2kg

**Canterbury Plus 1220 x 2440 rectangular dining table**  
1CBPT-1220X2440  
740H | 1220W | 2440D (mm)  
Weight: 81.4kg

KEY FEATURES	OPTIONS	
<ul style="list-style-type: none"> <li>→ Extremely substantial table with wood effect laminate top – heat and impact resistant</li> <li>→ Fully cross-braced solid beech frame and 90mm diameter turned legs for extra strength and stability</li> <li>→ Double thickness rails, mortise and tenon jointed into 92mm square corner posts</li> </ul>	<ul style="list-style-type: none"> <li>→ Lower risk Canterbury range available</li> </ul> <p><i>Double thickness rails and cross braced frame create exceptional strength</i></p>	





# DON



**Don square dining table**  
1DNT-005  
740H | 915W | 915D (mm)

**Don square dining table**  
1DNT-1065X1065  
740H | 1065W | 1065D (mm)



**Don 'D-end' table**  
1DNT-915X1675-DEND  
740H | 1675W | 915D (mm)



**Don round dining table**  
1DNT-915  
740H | ø 915 (mm)

**Don round dining table**  
1DNT-1065  
740H | ø 1065 (mm)

**Don round dining table**  
1DNT-1220  
740H | ø 1220 (mm)



**Don rectangular table**  
1DNT-1  
740H | 915W | 610D (mm)

**Don rectangular table**  
1DNT-760X1220  
740H | 1220W | 760D (mm)

**Don rectangular table**  
1DNT-760X1525  
740H | 1525W | 760D (mm)

**Don rectangular table**  
1DNT-915X1220  
740H | 1220W | 915D (mm)

**Don rectangular table**  
1DNT-915X1830  
740H | 1830W | 915D (mm)

**Don rectangular table**  
1DNT-915X1525  
740H | 1525W | 915D (mm)

## KEY FEATURES

- Natural wood effect laminate top  
- heat and impact resistant
- Solid beech frame
- Softened edges for safety

## OPTIONS

- Don Extra is suitable for wheelchair users
- Available in Natural and Walnut finish



*Also available - wheelchair accessible Don Extra*





# HARBY



*Replaces our popular Hamble range*



**Harby 600 x 900 rectangular dining table**  
1HYT-600x900  
748H | 600W | 900D (mm)



**Harby 760 x 1200 rectangular dining table**  
1HYT-760x1200  
748H | 760W | 1200D (mm)



**Harby round dining table**  
1HYT-900  
748H | ø 900 (mm)

**Harby round dining table with laminate top**  
1HYT-909  
748H | ø 900 (mm)

KEY FEATURES	OPTIONS	
→ Natural wood effect melamine top for easy cleaning	→ Round table available with heat and impact resistant laminate top	
→ Solid beech frame with tapered legs		
→ Softened edges for safety		





# ORIANA



**Oriana square dining table**  
1OAT-1  
740H | 915W | 915D (mm)



**Oriana round dining table**  
1OAT-6  
740H | ø 1065 (mm)



**Oriana rectangular table**  
1OAT-8  
740H | 760W | 1220D (mm)



**Oriana rectangular table**  
1OAT-5  
740H | 915W | 1830D (mm)



**Oriana round dining table**  
1OAT-915  
740H | ø 915 (mm)



**Oriana round dining table**  
1OAT-1220  
740H | ø 1220 (mm)



**Oriana rectangular table**  
1OAT-915X1525  
740H | 915W | 1525D (mm)



**Oriana 'D-end' table**  
1OAT-915X1675-DEND  
740H | 915W | 1675D (mm)

## KEY FEATURES

- Natural wood effect laminate top  
- heat and impact resistant
- Bent plywood legs with softened edges for safety
- Suitable for wheelchair users





# OLAND



**Oland round dining table**  
1OLT-10  
740H | ø 915 (mm)



**Oland square dining table**  
1OLT-915X915  
740H | 915W | 915D (mm)



**Oland rectangular table**  
1OLT-915X1525  
740H | 915W | 1525D (mm)



**Oland 'D-end' table**  
1OLT-915X1675-DEND  
740H | 915W | 1675D (mm)



**Oland round dining table**  
1OLT-12  
740H | ø 1065 (mm)



**Oland rectangular table**  
1OLT-760X1220  
740H | 760W | 1220D (mm)



**Oland rectangular table**  
1OLT-915X1830  
740H | 915W | 1830D (mm)

## KEY FEATURES

- Natural wood effect laminate top  
- heat and impact resistant
- Solid beech curved frame with softened edges for safety
- Corners braced for additional strength
- Matching coffee tables (See page 153)







# GANT EXTRA



**Gant Extra dining set**  
 1GE4-500  
 830H | 1860W | 1860D (mm)  
 Seat height: 455mm  
 Table Height: 720mm  
 Table Top - ø 800mm

KEY FEATURES	OPTIONS	
<ul style="list-style-type: none"> <li>→ Natural wood effect laminate top - heat and impact resistant</li> <li>→ Padded seats for comfort</li> <li>→ Inaccessible staples and security screws as standard</li> <li>→ Integral floor mounting brackets for additional security</li> </ul>	<ul style="list-style-type: none"> <li>→ Standard Gant also available</li> <li>→ Wide choice of water-resistant upholstery</li> </ul> 	



**BEDROOM**

**FURNITURE FOR PRIVATE**

**SPACES WHERE SAFETY**

**IS PARAMOUNT**





# HARBY



*Replaces our popular Hamble range*



**Harby 1 door, 1 drawer bedside cabinet**  
1HYB-110  
590H | 400W | 450D (mm)



**Harby 1 drawer bedside cabinet**  
1HYB-100  
590H | 400W | 450D (mm)



**Harby 3 drawer bedside cabinet**  
1HYB-300  
590H | 400W | 450D (mm)



**Harby 3 drawer wide chest**  
1HYC-300  
590H | 760W | 450D (mm)



**Harby 4 drawer wide chest**  
1HYC-400  
740H | 760W | 450D (mm)



**Harby 4 drawer desk**  
1HYD-400  
740H | 1050W | 600D (mm)

KEY FEATURES	OPTIONS	
→ 28mm thick tops and 18mm hickory melamine-faced carcass	→ Locks to doors and drawers	
→ Double thickness drawer fronts with 18mm back and sides and 10mm drawer bottoms result in very robust drawers	→ Available as Harby Plus with reduced ligature handles (see pages 214-219)	
→ Robust 160° opening hinges on all doors		
→ Durable metal drawer runners		



# HARBY



**Harby 1 door wardrobe**  
1HYW-100  
1800H | 600W | 600D (mm)



**Harby 2 door wardrobe**  
1HYW-200  
1800H | 875W | 600D (mm)



**Harby combination wardrobe**  
1HYWC-200  
1800H | 875W | 600D (mm)

# HARBY



**Harby 1/2 hanging,  
1/2 shelved wardrobe**  
1HYWH-200  
1800H | 875W | 600D (mm)



**Harby wall mirror**  
1HYK-100  
600H | 500W | 18D (mm)

KEY FEATURES	OPTIONS	
<ul style="list-style-type: none"> <li>→ 28mm thick tops and 18mm hickory melamine-faced carcass</li> <li>→ Double thickness drawer fronts with 18mm back and sides and 10mm drawer bottoms result in very robust drawers</li> <li>→ Robust 160° opening hinges on all doors</li> <li>→ Durable metal drawer runners</li> </ul>	<ul style="list-style-type: none"> <li>→ Locks to doors and drawers</li> <li>→ Available as Harby Plus with reduced ligature handles (see pages 214-219)</li> </ul>	

KEY FEATURES	OPTIONS	
<ul style="list-style-type: none"> <li>→ 28mm thick tops and 18mm hickory melamine-faced carcass</li> <li>→ Double thickness drawer fronts with 18mm back and sides and 10mm drawer bottoms result in very robust drawers</li> <li>→ Robust 160° opening hinges on all doors</li> <li>→ Durable metal drawer runners</li> </ul>	<ul style="list-style-type: none"> <li>→ Locks to doors and drawers</li> <li>→ Available as Harby Plus with reduced ligature handles (see pages 214-219)</li> </ul>	









## HARBY PLUS



*Replaces our popular  
Hamble range*



**Harby Plus 1 door, 1  
drawer bedside cabinet**  
1HYPB-110  
590H | 400W | 450D (mm)



**Harby Plus 1 drawer  
bedside cabinet**  
1HYPB-100  
590H | 400W | 450D (mm)



**Harby Plus 3 drawer  
bedside cabinet**  
1HYPB-300  
590H | 400W | 450D (mm)



**Harby Plus 3 drawer  
wide chest**  
1HYPC-300  
590H | 760W | 450D (mm)



**Harby Plus 4 drawer  
wide chest**  
1HYPC-400  
740H | 760W | 450D (mm)



**Harby Plus 4 drawer desk**  
1HYPD-400  
740H | 1050W | 600D (mm)

### KEY FEATURES

- 28mm thick tops and 18mm hickory melamine-faced carcass
- Double thickness drawer fronts with 18mm back and sides and 10mm drawer bottoms result in very robust drawers
- Handles styled to reduce ligature risks
- Piano hinges to reduce ligature risks
- Drawer stops prevent removal of drawers
- Security fixings as standard

### OPTIONS

- Locks to doors and drawers
- 270° hinges to reduce risk of damage



# HARBY PLUS



**Harby Plus 1 door wardrobe**  
1HYPW-100  
1800H | 600W | 600D (mm)



**Sloping top single wardrobe**  
1HYPWT-100  
410H | 600W | 600D (mm)



**Harby Plus 2 door wardrobe**  
1HYPW-200  
1800H | 875W | 600D (mm)



**Harby Plus combination wardrobe**  
1HYPWC-200  
1800H | 875W | 600D (mm)

KEY FEATURES		OPTIONS
→ 28mm thick tops and 18mm hickory melamine-faced carcass	→ Fixed shelves to prevent misuse	→ Locks to doors and drawers
→ Double thickness drawer fronts with 18mm back and sides and 10mm drawer bottoms result in very robust drawers	→ Handles styled to reduce ligature risks	→ 270° hinges to reduce risk of damage
→ Half-depth reduced-ligature shelf	→ Piano hinges to reduce ligature risks	→ Sloping top to prevent climbing and allow thorough inspection
	→ Drawer stops prevent removal of drawers	
	→ Security fixings as standard	

# HARBY PLUS



**Harby Plus 1/2 hanging, 1/2 shelved wardrobe**  
1HYPWH-200  
1800H | 875W | 600D (mm)



**Harby Plus twin hanging wardrobe**  
1HYPW22-200  
1800H | 875W | 600D (mm)



**Sloping top double wardrobe**  
1HYPWT-200  
410H | 875W | 600D (mm)



**Harby Plus polycarbonate wall mirror**  
1HYPK-100  
600H | 500W | 18D (mm)

KEY FEATURES		OPTIONS
→ 28mm thick tops and 18mm hickory melamine-faced carcass	→ Piano hinges to reduce ligature risks	→ Locks to doors and drawers
→ Half-depth reduced-ligature shelf	→ Security fixings as standard	→ 270° hinges to reduce risk of damage
→ Fixed shelves to prevent misuse		→ Sloping top to prevent climbing and allow thorough inspection
→ Handles styled to reduce ligature risks		





# HARBY PLUS OPEN

*Replaces our popular Hamble range*



**Harby Plus Open twin hanging wardrobe**  
1HYPWO22-200  
1800H | 875W | 600D (mm)



**Harby Plus Open 1/2 hanging, 1/2 shelved wardrobe**  
1HYPOWH-200  
1800H | 875W | 600D (mm)



**Sloping top double wardrobe**  
1HYPWT-200  
410H | 875W | 600D (mm)



**Harby Plus Open chest with 4 compartments**  
1HYPCO-400  
740H | 760W | 450D (mm)



**Harby Plus Open desk with 4 compartments**  
1HYPDO-400  
740H | 1050W | 600D (mm)



**Harby Plus Open bedside with 3 compartments**  
1HYPBO-300  
590H | 400W | 450D (mm)

## KEY FEATURES

- 28mm thick tops and 18mm hickory melamine-faced carcass
- Designed without doors for safety and durability
- Half-depth shelf with groove instead of clothes rail to minimise ligature risks

- Fixed shelves with reinforcement panels to prevent misuse
- Security fixings as standard



## OPTIONS

- Sloping top to prevent climbing and allow thorough inspection

*Designed without doors and drawers to further reduce ligature risks*



# ACUMEN

<p>Enclosed underside eliminates concealment opportunities <i>below</i></p>		
	<p>Half-depth shelf with groove instead of clothes rail to minimise ligature risks <i>above</i></p>	
<p>Continuous hinges minimise ligature risks <i>right</i></p>	<p>Inset handles reduce ligature risks <i>above</i></p> <p>Curved door tops and optional sloping top prevent climbing and allow inspection <i>right</i></p>	

Acumen has been specially designed for challenging environments with reduced-ligature features and minimised concealment opportunities.

<p>Drawer fronts are inset into the cabinet for added durability <i>left</i></p>	
----------------------------------------------------------------------------------	--------------------------------------------------------------------------------------

<p>Strong cam and dowel construction with glued wooden dowels for added durability</p> 		<p>Security fixings to deter tampering</p> <p>Heavy-duty drawer runners with 45kg load carrying capacity</p> <p>10mm thick bottom creates added rigidity</p>
------------------------------------------------------------------------------------------------------------------------------------------------------------------------------	--------------------------------------------------------------------------------------	--------------------------------------------------------------------------------------------------------------------------------------------------------------





## ACUMEN WHITE



**Acumen 1-door, 1-drawer  
bedside cabinet**  
1AUB-101-WW  
595H | 450W | 480D (mm)  
Weight: 36.5kg



**Acumen 4-drawer  
wide chest**  
1AUC-400-WW  
835H | 810W | 485D (mm)  
Weight: 82kg



**Acumen 4-drawer  
desk**  
1AUD-400-WW  
735H | 1085W | 485D (mm)  
Weight: 79kg

**Acumen wall mirror**  
1AUK-001-W  
500H | 600W | 18D (mm)  
Weight: 6kg



**Acumen 2-door  
wardrobe**  
1AUW2-001-WW  
1800H | 925W | 635D (mm)  
Weight: 110kg



**Acumen combination  
wardrobe**  
1AUWC-001-WW  
1800H | 925W | 635D (mm)  
Weight: 139kg



**Acumen 1/2 hanging, 1/2  
shelved wardrobe**  
1AUWH-001-WW  
1800H | 925W | 635D (mm)

**Sloping top**  
1AUWT-001-W  
460H | 925W | 635D (mm)



### KEY FEATURES

- 28mm thick tops and 18mm walnut melamine-faced carcass
- Double thickness drawer fronts with 18mm back and sides and 10mm drawer bottoms result in very robust drawers
- Scalloped handles, piano hinges and curved door tops reduce ligature risks
- Heavy-duty drawer runners (rated to 45kg)

- Half-depth shelf with a groove instead of clothes rail to minimise ligature risks
- Specially designed to minimise concealment areas (e.g. underside, between drawers)
- Heavily weighted to deter misuse
- Security fixings to prevent tampering

### OPTIONS

- Locks to doors and drawers for security
- Wardrobes available with sloping top box to prevent climbing
- Also available in Hickory finish with Grey doors







## ACUMEN GREY



**Acumen 1-door, 1-drawer  
bedside cabinet**  
1AUB-101-HG  
595H | 450W | 480D (mm)  
Weight: 36.5kg



**Acumen 4-drawer  
wide chest**  
1AUC-400-HG  
835H | 810W | 485D (mm)  
Weight: 82kg



**Acumen 4-drawer  
desk**  
1AUD-400-HG  
735H | 1085W | 485D (mm)  
Weight: 79kg

**Acumen wall mirror**  
1AUK-001-H  
500H | 600W | 18D (mm)  
Weight: 6kg



**Acumen 2-door  
wardrobe**  
1AUW2-001-HG  
1800H | 925W | 635D  
Weight: 110kg



**Acumen combination  
wardrobe**  
1AUWC-001-HG  
1800H | 925W | 635D (mm)  
Weight: 139kg



**Acumen 1/2 hanging, 1/2  
shelved wardrobe**  
1AUWH-001-HG  
1800H | 925W | 635D (mm)

**Sloping top**  
1AUWT-001-W  
460H | 925W | 635D (mm)



### KEY FEATURES

- 28mm thick tops and 18mm hickory melamine-faced carcass
- Double thickness drawer fronts with 18mm back and sides and 10mm drawer bottoms result in very robust drawers
- Scalloped handles, piano hinges and curved door tops reduce ligature risks
- Heavy-duty drawer runners (rated to 45kg)
- Half-depth shelf with a groove instead of clothes rail to minimise ligature risks
- Specially designed to minimise concealment areas (e.g. underside, between drawers)
- Heavily weighted to deter misuse
- Security fixings to prevent tampering

### OPTIONS

- Locks to doors and drawers for security
- Wardrobes available with sloping top box to prevent climbing
- Also available in Walnut finish with White doors







# ACUMEN OPEN



**Acumen Open bedside cabinet with 2 compartments**  
1AUOB-200  
595H | 450W | 480D (mm)



**Acumen Open desk with 4 compartments**  
1AUOD-400  
735H | 1085W | 485D (mm)



**Acumen Open wide chest with 4 compartments**  
1AUOC-400  
835H | 810W | 485D (mm)



**Acumen Open ½ hanging, ½ shelved wardrobe**  
1AUOWH-001  
1800H | 925W | 635D (mm)

## KEY FEATURES

- 28mm thick tops and 18mm melamine-faced carcass
- Half-depth shelf with a groove instead of clothes rail to minimise ligature risks
- Specially designed to minimise concealment areas (e.g. underside, between drawers)
- Stepped shelves to deter climbing
- Fixed shelves with reinforcement panels to prevent misuse
- Heavily weighted to deter misuse
- Security fixings to prevent tampering

## OPTIONS

- Sloping top to prevent climbing and allow thorough inspection
- Available in Hickory and Walnut finish



*Designed without doors and drawers to further reduce ligature risks*







# HARBY BEDS

Replaces our popular Hamble range



**Harby single 3' bed**  
1HYA3-100  
395H | 1985L | 990W (mm)



**Harby 4' bariatric bed**  
1HYA4-100  
395H | 1985L | 1280W (mm)



Static weight tested to



**Harby 3' headboard**  
1HYH-300  
600H | 920W | 18D (mm)



**Harby 3' wall-mounted headboard**  
1HYH-301  
870H | 920W | 18D (mm)



**Harby double 4'6" bed**  
1HYA46-100  
395H | 1985L | 1450W (mm)  
(Assembled at point of delivery)



**Harby 3' bed with internal storage**  
1HYA3-500  
395H | 1985L | 990W (mm)

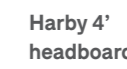

**Harby 4' headboard**  
1HYH-400  
600H | 1220W | 18D (mm)

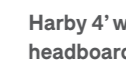

**Harby 4' wall-mounted headboard**  
1HYH-401  
870H | 1220W | 18D (mm)

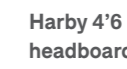

**Harby 4'6" headboard**  
1HYH-460  
600H | 1370W | 18D (mm)

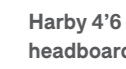

**Harby 4'6" wall-mounted headboard**  
1HYH-461  
600H | 1370W | 18D (mm)

KEY FEATURES		
→ 28mm side panels for strength with solid reinforced under rails		
→ Enclosed base to minimise concealment opportunities		
→ Heavyweight to deter misuse		





# ACUMEN BED



**Acumen single 3' bed**  
 1AUA-101  
 445H | 2002L | 998W (mm)  
 Weight: 95kg



**Acumen double 4'6'' bed**  
 1AUA-460  
 445H | 2002L | 1428W (mm)



**Acumen 3' headboard**  
 1AUH-001  
 600H | 998W | 18D (mm)



**Acumen 3' wall-mounted headboard**  
 1AUH-301  
 870H | 998W | 18D (mm)

**Acumen 4'6'' headboard**  
 1AUH-460  
 600H | 1428W | 18D (mm)

**Acumen 4'6'' wall-mounted headboard**  
 1AUH-461  
 870H | 1428W | 18D (mm)

## KEY FEATURES

- 28mm side panels for strength with solid reinforced under rails
- Enclosed base to minimise concealment opportunities
- Heavyweight to deter misuse
- Smooth rounded corners for safety

## OPTIONS

→ Available in Hickory and Walnut finish





# SOVIE

This range has been designed to provide an ideal safety solution for beds in challenging environments.



**Strength**  
Internal support ribs provide extra strength and durability



**Water resistance**  
Sovie's one-piece mattress platform has no joints or crevices through which liquid can permeate, preserving hygiene and infection control levels



## Kydex material

The Sovie bed is coated in Kydex – a tough plastic which is commonly found in aircraft interiors. Kydex is an extremely durable finish which withstands impact and is resistant to tough chemical cleaners.

### Flame retardant

Kydex has flame retardant properties:

- Achieves Class A rating (the highest) for ASTM E-84\* surface burning characteristics of building materials
- Is self extinguishing in the absence of an external flame

### Anti-bacterial

Kydex resists bacterial and fungal development:

- It provides no source of nutrients (unlike some other plastics)
- Passed ASTM G-21\* (bacteria) and ASTM G-22\* (fungus) by supporting no bacterial or fungal growth

### Chemically resistant

Kydex remains unaffected by some of the harshest chemicals:

- 70% Nitric acid
- 30% Sulphuric acid
- 10% Hydrochloric acid
- Ammonia
- 3% Hydrogen



### Installation

Beds can be securely fixed to the floor, using infill panels to minimise concealment opportunities when positioned against a wall





**Weir safety mirror**  
1WEIRK-100  
1100H | 310W | 25D (mm)

**Sovie headboard**  
1SVEAH-001  
480H | 980W | 20D (mm)

# SOVIE BEDS



Static weight tested to  500KG



**Sovie single 3' box bed**  
1SVEA-100  
470H | 1950L | 980W (mm)  
Mattress tray: 1880L | 910W (mm)  
Weight: 120kg



**Sovie Flare single 3' bed**  
1SVFA-100  
480H | 1990L | 990W (mm)  
Mattress tray: 1880L | 910W (mm)  
Weight: 110kg

**Sovie Flare bariatric 4' bed**  
1SVFAB4-100  
480H | 2112L | 1200W (mm)  
Mattress tray: 2032L | 1120W (mm)

KEY FEATURES	OPTIONS	
<ul style="list-style-type: none"> <li>→ Water-resistant one-piece mattress tray</li> <li>→ Internal support ribs provide extra strength and durability</li> <li>→ Extremely durable Kydex finish which is water-resistant, stain resistant, anti-bacterial &amp; flame-retardant</li> <li>→ Suitable for use with our foam mattresses Single beds: 915 x 1900mm mattress Bariatric bed: 1120 x 2032mm mattress</li> </ul>	<ul style="list-style-type: none"> <li>→ Invisible floor fixing method – please advise when placing an order</li> <li>→ Available in White and Hickory finish</li> </ul> <div style="display: flex; align-items: center; gap: 10px;"> <input type="radio"/> <input checked="" type="radio"/> </div>	





# ZURICH BEDS



**Zurich single 3' bed**  
 1ZHA-1  
 340H | 1905L | 900W (mm)



**Zurich double 4'6" bed**  
 1ZHA-2  
 340H | 1905L | 1400W (mm)

KEY FEATURES		
→ Extremely strong welded construction with mesh base		
→ Rounded corners for safety		
→ One-piece ski legs for strength		
→ Powder coated tough 50mm x 25mm steel box section frame		





Scorpio mattress for Ryno bed available - see page 53

# SCORPIO

2



	Single 3' (915mm)	Small double 4' wide (1220mm)	Double 4'6" wide (1370mm)
<b>5" (125mm) thick</b>	1SOMS-001 125H   1900L   900W (mm)	1SOM4-63-5-C5 125H   1900L   1220W (mm)	1SOM46-63-5-C5 125H   1900L   1370W (mm)
<b>7" (180mm) thick</b>	1SOMS-002 180H   1900L   900W (mm)	1SOM4-63-7-C5 180H   1900L   1220W (mm)	1SOM46-63-7-C5 180H   1900L   1370W (mm)
<b>13" (330mm) thick</b>	1SOM3-63-13-C5 330H   1900L   900W (mm)	1SOM4-63-13-C5 330H   1900L   1220W (mm)	1SOM46-63-13-C5 330H   1900L   1370W (mm)
<b>21" (530mm) thick</b>	1SOM3-63-21-C5 530H   1900L   900W (mm)	1SOM4-63-21-C5 530H   1900L   1220W (mm)	1SOM46-63-21-C5 530H   1900L   1370W (mm)

## KEY FEATURES

- Tear-resistant, fire-retardant, anti-vandal polyurethane cover
- Water-resistant heat welded seams to prevent liquid penetration – ideal for incontinence
- CMHR foam interior

## OPTIONS

- Available with integral pillow
- Available fire retardant to BS7177 source 5 and BS7177 source 7

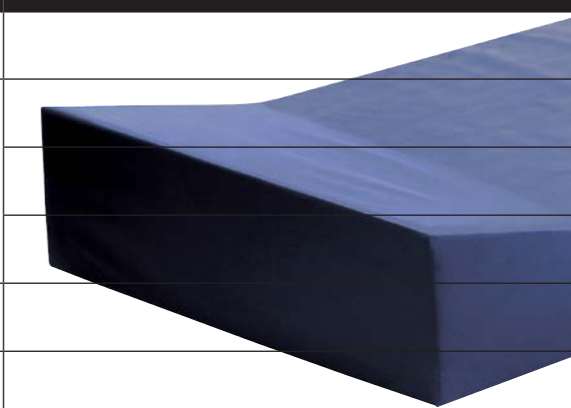





# SCORPIO COLLAPSIBLE

Versatile design serves multiple functions including making it usable for soft seating

The patented design of our Scorpio collapsible mattress (No.GB2572141) prevents obscuring of vision panels as it ‘collapses’ when stood on end.

	<p>Available fire-retardant to BS7177 Ignition Source 5 or Ignition Source 7</p>		<p>An optional security under layer makes damage more noticeable during staff inspection</p>		<p>Unlike separate pillows, the optional integral pillow cannot be used to as a weapon or to block plumbing</p>
--	----------------------------------------------------------------------------------	--	----------------------------------------------------------------------------------------------	--	-----------------------------------------------------------------------------------------------------------------

## SCORPIO COLLAPSIBLE



Scorpio Collapsible anti-vandal foam mattress Crib 5  
1SOM26-63-3-TRIFOLDC5  
76H | 1900L | 760W (mm)

Scorpio Collapsible anti-vandal foam mattress Crib 7  
1SOM26-63-3-TRIFOLDC7  
76H | 1900L | 760W (mm)

KEY FEATURES	OPTIONS	
<ul style="list-style-type: none"> <li>→ Tri-folding design to stop it from being stood on its end as an obstruction to viewing panels</li> <li>→ Tear-resistant, fire-retardant, anti-vandal polyurethane cover</li> <li>→ Water-resistant heat welded seams to prevent liquid penetration – ideal for incontinence</li> <li>→ CMHR foam interior</li> </ul>	<ul style="list-style-type: none"> <li>→ Available with integral pillow</li> <li>→ Available fire retardant to BS7177 source 5 and BS7177 source 7</li> </ul>	



# POLAR



	Single 3' (915mm)	Small double 4' wide (1220mm)	Double 4'6" wide (1370mm)
5" (125mm) thick	1PRMS-001 125H   1900L   900W (mm)	1PRM4-63-5-C5 125H   1900L   1220W (mm)	1PRM46-63-5-C5 125H   1900L   1370W (mm)
7" (180mm) thick	1PRMS-002 180H   1900L   900W (mm)	1PRM4-63-7-C5 180H   1900L   1220W (mm)	1PRM46-63-7-C5 180H   1900L   1370W (mm)
13" (330mm)thick	1PRAS-001 330H   1900L   900W (mm)	1PRM4-63-13-C5 330H   1900L   1220W (mm)	1PRM46-63-13-C5 330H   1900L   1370W (mm)
21" (530mm) thick	1PRM3-63-21-C5 530H   1900L   900W (mm)	1PRM4-63-21-C5 530H   1900L   1220W (mm)	1PRM46-63-21-C5 530H   1900L   1370W (mm)

## KEY FEATURES

- Hygienic wipe-clean surface
- Water-resistant heat welded seams to prevent liquid penetration – ideal for incontinence
- CMHR foam interior

## OPTIONS

- Available with integral pillow
- Available fire retardant to BS7177 source 5 or BS7177 source 7

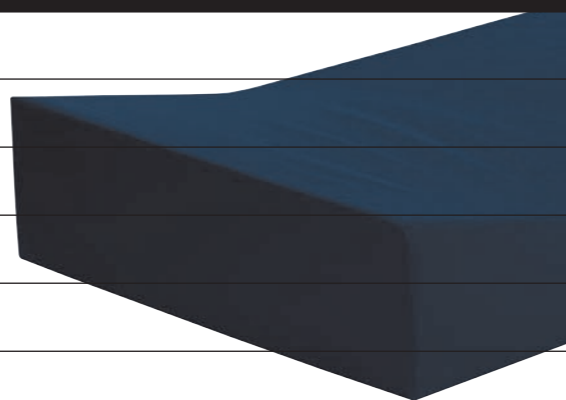

# MONSOON PRESSURE RELIEVING



**Monsoon single 3' mattress**  
1MNM-001-C5  
180H | 1900L | 915W (mm)

# AQUARIUS



	Single 3' (915mm)	Small double 4' wide (1220mm)	Double 4'6" wide (1370mm)
<b>Mattress</b>	1AQM-002 125H   1900L   915W (mm)	1AQM4-001 125H   1900L   1220W (mm)	1AQM-004 125H   1900L   1370W (mm)
<b>Divan bed base</b>	1AQA-002 400H   1900L   915W (mm)	1AQA4 400H   1900L   1220W (mm)	1AQA-004 400H   1900L   1370W (mm)

## KEY FEATURES MONSOON

- Pressure relieving CMHR foam interior
- Water-resistant heat welded seams to prevent liquid penetration – ideal for incontinence

## KEY FEATURES AQUARIUS

- Open-coil sprung mattress interior
- Layers of insulation and quilting for comfort
- Water-resistant, anti-bacterial breathable cover

**Please note:** Fluid can still penetrate stitching.  
For fully waterproof mattresses, please see Polar, Scorpio and Monsoon.



# NEXT STEPS

NOW IT'S TIME TO

MAKE ANY FABRIC

CHOICES AND PLACE

YOUR ORDER



# UPHOLSTERY



We provide an extensive range of water-resistant fabrics and vinyls to ensure that you will find the right finish for your furniture.

## Fabrics

A durable option which combines the comfort of soft fabric with practical water resistant properties. Please be aware, these fabrics are more susceptible to stains than vinyl.



Call us to request your fabric swatch cards to see the full choice available

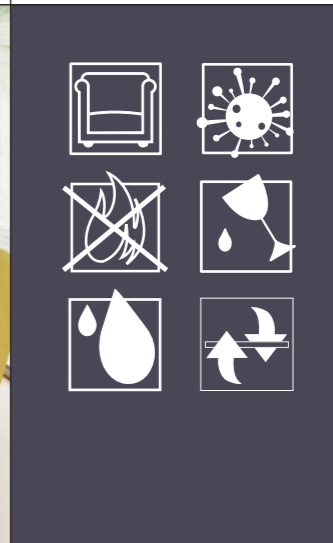

## Vinyls

Hard wearing and water resistant, leather-effect vinyls can be wiped clean which makes them a hygienic and practical option for healthcare environments.



100,000  
MARTINDALE  
RUBS



LATEX  
FREE



Call us to request your fabric swatch cards to see the full choice available







Some of our ranges are available using dual fabrics to add multiple textures and colours to one item of furniture.



Please note: Cracking and stickiness on vinyl fabrics are known issues to fabric manufacturers. As furniture manufacturers, Pineapple cannot accept responsibility.



# HOW TO PLACE YOUR ORDER

Step		Step		Step	
<b>01</b>	Pick your furniture	<b>02</b>	Pick your fabric or finish	<b>03</b>	Get in touch for a quote
					
			Visit our website to see our latest fabrics and request a free swatch		

Need assistance? We're on hand to help

	+44(0)1622 237830		sales@pineapplecontracts.com		Chat to us at www.pineapplecontracts.com
---------------------------------------------------------------------------------------	-------------------	---------------------------------------------------------------------------------------	------------------------------	---------------------------------------------------------------------------------------	---------------------------------------------



# INDEX

<b>Acumen</b>		<b>Chairs</b>	
→ Lounge	163	→ Dining	33, 37, 39, 168-189
→ TV Cabinets	165	→ Lounge	31, 35, 124-145
→ Coffee Tables	159	→ Children's chair	39
→ Bedroom	222-227	<b>Cheltenham</b>	137
→ Open	229	Children's table	191
→ Bed	233	Coffee tables	35, 77, 149-159
<b>Akessen Plus</b>	101	<b>Contessa</b>	121
<b>Aquarius</b>	245	<b>Cumulus Plus</b>	190-193
<b>Aruba</b>	103	Cupboards	161-163
Bariatric chairs	35, 89, 127	De-escalation Sofas	110-117
Beds	53, 230-239	Desks	51, 211, 217, 221, 225-229
Beanbags	119	Dining tables	41, 190-207
Benches	45	<b>Domus Plus</b>	61
<b>Bedroom</b>	48-53, 208-245	<b>Don</b>	199
→ Bedroom cabinets	51, 211-229	<b>Eclipse</b>	125
→ Beds, mattresses & headboards	53, 230-245	<b>Ellern mede NG feeding couch</b>	117
<b>Boden</b>	119	<b>Fiji</b>	141
<b>Boss</b>	175	Foam beds & mattresses	240-245
<b>Boxer</b>	139	Footstools	71, 75, 124-129
<b>Cascade / Cascade Plus</b>	123	<b>Fusion</b>	171
<b>Canterbury Plus</b>	197	<b>Gant</b>	207

<b>Harby</b>	
→ Dining	201
→ Lounge	161
→ Bedroom	210-213
→ Beds	231
<b>Harby Plus</b>	
→ Coffee Tables	157
→ Bedroom	214-219
→ TV Cabinets	165
→ Open	221
<b>Harrier Plus</b>	97
<b>Helix Plus</b>	87
<b>Hobart Plus</b>	95
<b>Jak</b>	112-115
<b>Larsen</b>	
→ Lounge	127
→ Dining	185
<b>Liberty</b>	106-109
<b>Lichfield</b>	155
<b>Magna Plus</b>	80-83
<b>Monsoon</b>	245
Mattresses	240-245
<b>Neena</b>	151
<b>Nero</b>	177
<b>Nexus</b>	179
<b>Ohio Plus</b>	77
<b>Oland</b>	
→ Coffee	153
→ Dining	205
<b>Oriana</b>	203
<b>Oskar</b>	131
<b>Osprey Plus</b>	99
<b>Orr Plus</b>	88-91
<b>Polar</b>	244
<b>Purl Plus</b>	63
<b>Quadra Plus</b>	85
<b>Reef de-escalation</b>	111
<b>Rock</b>	149, 169, 195
<b>Rondo</b>	105
<b>Rubus Plus</b>	93

<b>Ryno</b>	24-55
→ Bedroom	48-53
→ Bench	45
→ Children's chair	39
→ Club chair	33
→ Coffee table	35
→ Dining chair	37
→ Dining tables	41
→ Lounge chair	35
→ Stool	43
→ Tub chair	31
<b>Scorpio</b>	240-243
<b>Sigma Plus</b>	69
<b>Skye plus</b>	65
<b>Sloane</b>	143
Sloping top boxes	214, 223-227
<b>Smile</b>	145
<b>Snug Plus</b>	75
Sofas	62-103
<b>Sovie</b>	234-237
Stools	43
<b>Tables</b>	
→ Coffee	35, 77, 148-159
→ Dining	41, 190-207
<b>Tempo Plus</b>	67
<b>Thor</b>	135
<b>Touch</b>	173
<b>Troy</b>	181
TV Cabinets	165
Upholstery / Vinyls / Fabrics	248-249
<b>Uppsala</b>	189
<b>Vee</b>	133
<b>Vision</b>	123
→ Lounge	123
→ Dining	187
<b>Xeon</b>	175
<b>Zen Plus</b>	69
→ Rocker	73
<b>Zurich</b>	239







**Pineapple**

 +44 (0)1622 237830

 Pineapple, Westmead, Aylesford, Maidstone, Kent ME20 6XJ

 [pineapplecontracts.com](http://pineapplecontracts.com)

 [sales@pineapplecontracts.com](mailto:sales@pineapplecontracts.com)

