

MAGNA 2.0 PLUS CHAIR

1MG1-900

769H | 944W | 852D (mm)

Seat Height: 447mm

Weight: 70.5kg



KEY FEATURES

- Plywood reinforcement for added strength
- 'Zero-depth' seams prevent concealment
- Fully enclosed base to prevent concealment
- Fixed seat and back cushions to prevent misuse
- Additionally weighted to deter misuse
- Strength and stability tested for severe contract use



MATERIAL/FABRICATION

Carcass made from a mix of particle board and plywood with plinth base on our Plus range, which prevents dust and dirt gathering underneath. Strong plywood reinforcement offers excellent levels of durability and strength. All cushions fixed to the base to ensure that they are not taken off with anti-stash seams option to prevent hiding of contraband. Cushioned areas made from fire retardant, CMHR (combustion modified high resilience) foam is safe for both users and staff.

TEST STANDARDS

- Fire retardant to BS7176:2007 source 5
- EN 16139: 2013, Test Level 2 (for adults weighing up to 110kg)
- Strength, Durability and Safety requirements for non-domestic seating ANSI / BIFMA X5.4-2020
- Static load internally tested up to 1 tonne (1000kg)

OPTIONS

- Available in armchair, 2-Seater and 3-Seater options
- Available in Standard or Plus levels or reinforcement
- Choose from Feet (1MG1-200) or a Plinth base design (1MG1-900)
- Plinth version is only available on the Plus range
- Floor fitting is only available on the Plus version with a Plinth

COLOUR/FINISH

Base options come in a Solid Birchwood with a Natural Lacquer finish

FABRIC

Available in a wide choice of fabrics including Vinyl, Waterproof, Non Waterproof and Leather

ASSEMBLY

Arrives assembled and ready to use

DELIVERY

Lead time 8-9 weeks

INSTALLATION/FITTING

No fitting required

MAINTENANCE

See upholstered furniture section of our care guidelines <https://uk.pineapplecontracts.com/upholstery/care-guidance/>

WARRANTY

7 year guarantee (does not include fabrics)

T

+44 (0)1622 237830

E

sales@pineapplecontracts.com

W

uk.pineapplecontracts.com

Pineapple

MAGNA 2.0 PLUS CHAIR

1MG1-900

769H | 944W | 852D (mm)

Seat Height: 447mm

Weight: 70.5kg

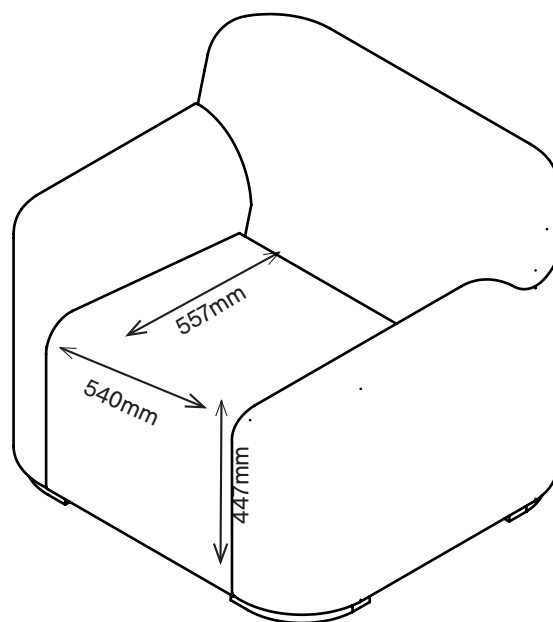
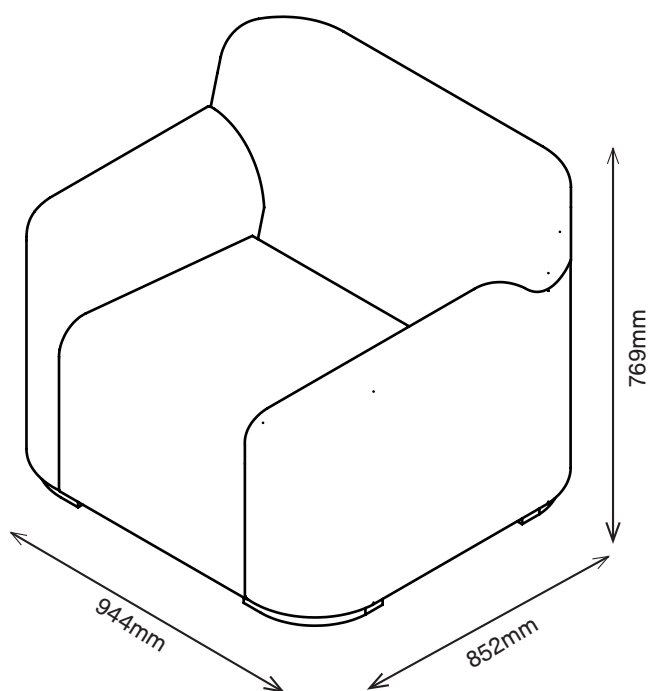

T
E
W

+44 (0)1622 237830

sales@pineapplecontracts.com

uk.pineapplecontracts.com

Pineapple