

# FURNITURE FOR MENTAL HEALTH ENVIRONMENTS



Designed for  
peace of mind

**Pineapple**





## IT ALL BEGAN IN

Our founder, William Hathorn, started our company in a workshop in London, England. Originally trading as Pine Productions, based on the popular wood we used to build our furniture, we crafted strong, durable products using traditional carpentry methods. But as our business grew and we began to provide furniture in a variety of materials for the healthcare market, the name no longer fitted. So, with a nod to our beginnings, we took a bold step and became Pineapple.

As our reputation for designing for demanding environments grew, so did demand for our products and we soon expanded into new premises, doubling our production capacity. We started creating technically advanced furniture for secure settings like mental health units and prisons, as well as lower risk spaces like hospitals, healthcare and education facilities.

# 1975

# TODAY

## 45 YEARS OF INNOVATION

We continue to create innovative furniture to deliver real-life solutions for our customers and, from initial concept right through to manufacture and delivery, we have full control of the process. All of our designs are either manufactured by us or by our carefully chosen partners who produce our furniture under license to meet our precise specification and design.

While our business is now international and our vision more ambitious than ever, we're still a family business at heart. Our work ethic and attention to detail is exactly the same as when we started in 1975.



THE PINEAPPLE PROCESS

We listen

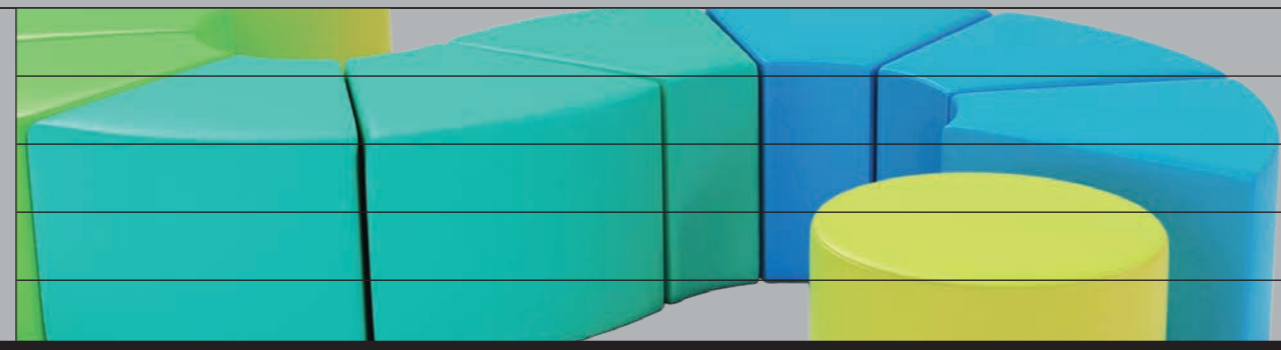

01

We listen more widely and more deeply to our customers' unique set of challenges; they might be safety concerns, maintenance issues or limited space. With forty years of experience under our belts, we're good at listening and know the right questions to ask.

02

understand

Drawing on our extensive knowledge gained over the last 50 years, we identify solutions that fit each brief. Then we define exactly what your furniture needs to deliver for your environment, taking physical, functional and emotional requirements into account.

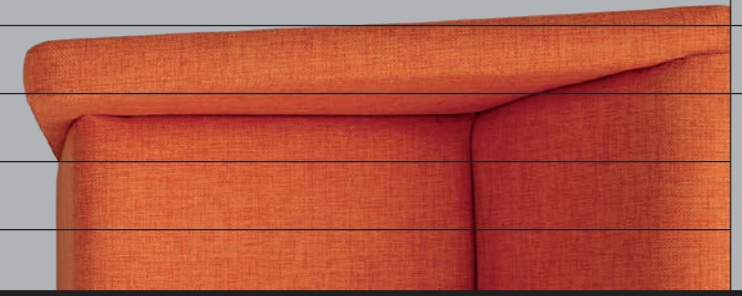
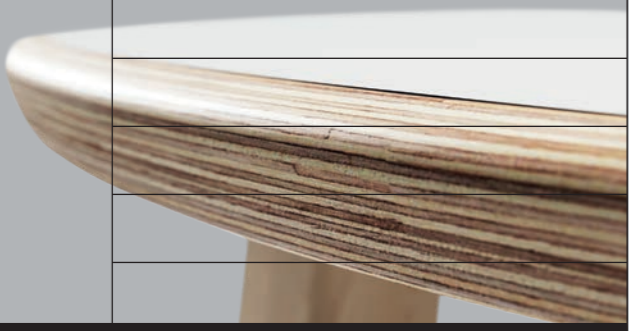

03

match

Now we understand your environment and precise needs, we can match you with the right products that will solve them. With hundreds of pieces to choose from, there is usually a solution that fits but if there isn't, we'll work with you to create one.

04

We deliver mindfully designed furniture that is exactly fit for purpose. We continue to learn from each new project, building the knowledge we gain into our new and existing product ranges to make them safer than ever.

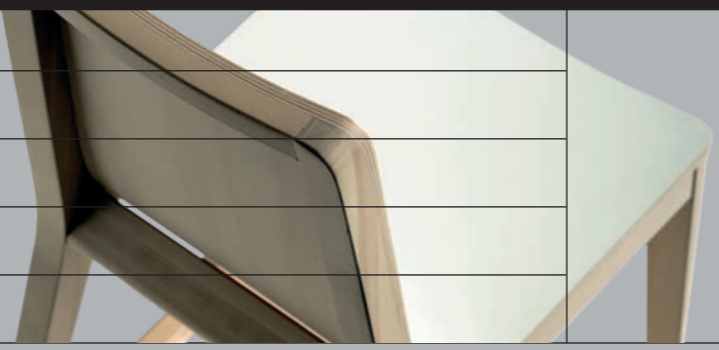

deliver



Photos by Dan Schwalm © 2023 HDR

This vibrant campus is designed to be a safe, therapeutic space for young people on juvenile probation.

# RADIUS CAMPUS

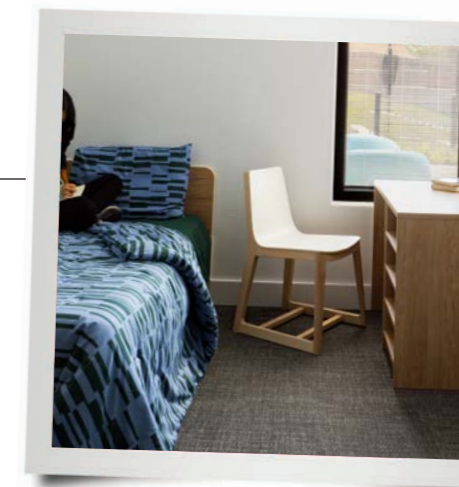

RADIUS is a non-profit organisation for young people on juvenile probation which aims to strengthen family and community relationships.

The campus provides 24 beds for youths aged between 12 and 18 years old, offering mental health and substance abuse treatment as well as building family support plans for their transition into the community.

In the vibrant community space, Rock tables and chairs provide space to work and play. The frames are made from solid Birch, cross-braced for strength, and the

table tops and seats are constructed from plywood, with a durable laminate surface.

Snug Plus modular sofas provide a comfortable place for residents to relax together in the TV lounge. Snug's reinforced construction ensures they are strong enough to withstand the rigours of challenging environments.

In the bedrooms, Harby Plus Open cabinetry provides safe and durable storage, with reinforced shelves and reduced-ligature design features as standard.



Photography by Chris Vaughan | © LPFT

The robust and durable Ryno® range excels outdoors thanks to its water-resistant and UV stabilised materials

# LINCOLN COUNTY HOSPITAL



Two state-of-the-art mental health wards have recently opened at the Peter Hodgkinson Centre situated at Lincoln County Hospital, enabling Lincolnshire Partnership NHS Foundation Trust (LPFT) to broaden its scope and offer invaluable care and support to adults who need mental health crisis support.

Ryno® club chairs and Ryno® pedestal tables were chosen to provide safe seating for the outside courtyard areas. The pedestal tables were securely fixed to the floor using our patented hidden fixings methods, while the Ryno® Club chairs were heavily weighted (to 62kg) to allow them to be repositioned without compromising safety.

The Club chair, distinguished by its sloped arm and curved back design was chosen for its reduced-ligature design, helping to create a safer environment for patients.

Our robust and durable Ryno® range excels outdoors thanks to its water-resistant and UV stabilised materials which provide dependable long-term durability. Combining an inspiring aesthetic with an emphasis on safety and comfort, Ryno products can contribute to environment that promotes healing and wellbeing for adults facing mental health challenges.



Bespoke fitted cabinetry and brightly coloured furniture helped to create a safe, homely environment for this child-focused home.

# LANSDOWNE CHILDREN'S HOME



Lansdowne Children's Home is a purpose-built secure children's home in East Sussex which provides accommodation and education facilities for young people, focusing on the educational, emotional and physical wellbeing of the children.

For the TV rooms and other communal spaces, we designed and installed bespoke fitted cabinetry to provide securely lockable storage space. The blues, greens and muted pink finish of the cabinetry follows the therapeutic colour palette seen throughout the building.

Ryno® dining chairs (weighted to 56kg to prevent misuse) were coupled with Cumulus Plus tables (weighted to 71kg) to provide safe and stylish furniture for dining or other activities.

All-foam Cascade Plus chairs provide soft seating with a tear-resistant anti-vandal cover. Heat welded seams make the chairs totally water-resistant which means they can be thoroughly cleaned and dry quickly, ready to be used again.

# CONTENTS

LEVELS OF SEVERITY	<b>3</b> ● ●	Level 3: Extremely resilient, these products are designed for extremely challenging environments
	● <b>2</b> ●	Level 2: Safe and secure, these products are recommended for challenging environments
	● ● <b>1</b>	Level 1: Durable and dependable, these products are suitable for lower risk environments

## RYNO®

Chairs, benches and stools	FROM PAGE 34
Dining tables and chairs	FROM PAGE 46
Bedroom furniture	FROM PAGE 52

## SOFT SEATING

Tub chairs and lounge chairs	FROM PAGE 64
Rocking chairs	PAGE 74, 126
Modular seating	FROM PAGE 76
Sofas (armchair, 2-seater, 3-seater)	FROM PAGE 86
Specialist seating	FROM PAGE 108
Beanbags and foam seating	FROM PAGE 122
General and waiting room seating	FROM PAGE 130

## LOUNGE

Coffee tables	FROM PAGE 144
Sideboards, cupboards and bookshelves	FROM PAGE 150
TV cabinets	FROM PAGE 154

## DINING

Dining chairs	FROM PAGE 158
Dining tables	FROM PAGE 178

## BEDROOM

Wardrobes, chest of drawers & storage	FROM PAGE 194
Beds	FROM PAGE 212
Mattresses	FROM PAGE 222



# SUSTAINABILITY

From operational efficiencies like solar power generation to seeking continual product-related improvements, our Sustainability department is dedicated to enacting our carbon reduction plan to help minimise our impact on the environment.

## Carbon Reduction Plan

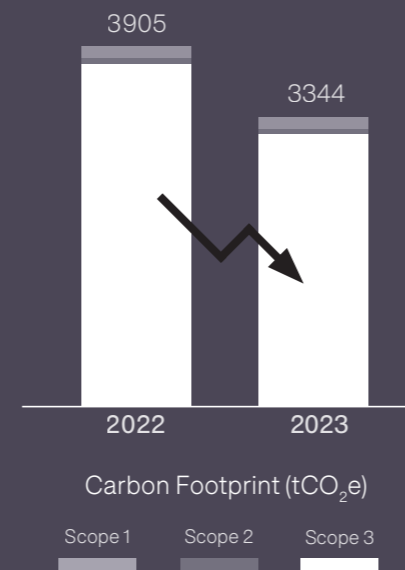

In our ongoing commitment to environmental responsibility, we have set a target to reduce our carbon emissions by 56% by 2030.

We measure Scope 1 (direct emissions from business operations), Scope 2 (emissions associated with energy generation) and Scope 3 (indirect emissions from supply chain and consumer waste streams).

Our Carbon Reduction Plan is already yielding significant achievements, including a 12% decrease in our overall greenhouse gas emissions from 2022 to 2023.

## Our Net Zero Journey

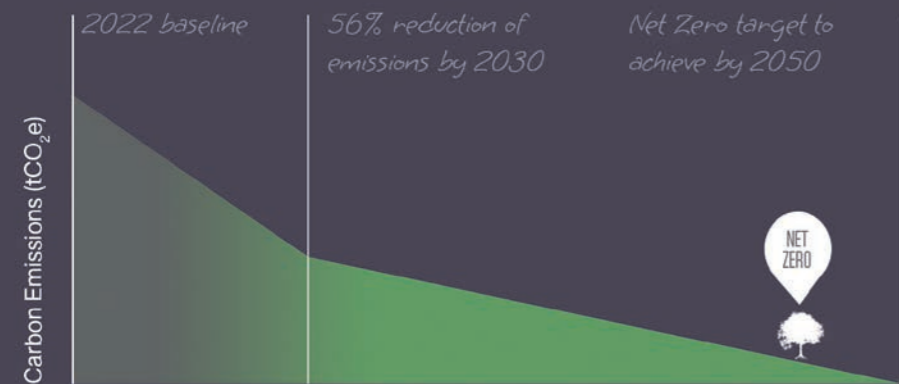

# HIGHLIGHTS



UK office energy generated by solar panels.



Decrease in CO<sub>2</sub> emissions from baseline.



Donated to charitable causes.



Decrease in packaging by weight.



Spent volunteering, improving biodiversity.



Eco products launched this year.

# TESTING

## Flame retardance



Flame retardant to contract level, all of our upholstery and fabrics meet BS 7176:2007 Source 0, 1 and 5 [Formerly BS5852 Source 0, 1 and 5].

We also supply fabric and mattresses which meet Crib Source 7.

This allows you to purchase with complete confidence knowing that all our products and fabrics are fully tried and tested.

## Durability testing



All of our furniture is strength and stability tested to contract level.

The picture above shows the Harrier sofa undergoing durability testing to BS EN 16139:2013 Level 2 (severe contract use).

In this demanding test, seat and back durability is tested at least 100,000 times.



## Static load testing

Our products are designed to withstand severe daily treatment. One of the ways we test this is the static load test.

During this test, a heavy weight is applied to the seat of the product.

Many of our products have been tested to withstand a 500kg static load.



# INFECTION CONTROL

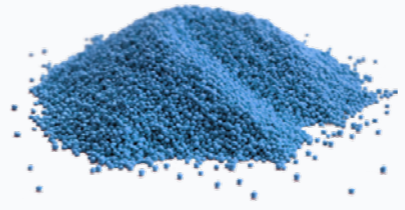

**Ryno® products** are made from our unique polymer blend which contains an anti-bacterial additive to inhibit bacterial growth. Unlike surface treatments which may wear away or become scratched, this anti-bacterial protection works throughout the product.



We apply an **anti-bacterial lacquer** to exposed wood surfaces which kills 99.9% of bacteria (including MRSA, C. diff and E. coli) within 24 hours by providing no source of nutrients which they need to survive.



Our upholstery ranges include anti-bacterial treatments which physically damage the cell walls, with tests showing a 99.99% reduction in MRSA and a 99.98% reduction in E. coli over 24hrs.

A number of our products feature a hygiene gap between the back and seat of the chair which prevents dust and dirt becoming trapped, making them easier to clean thoroughly.



Our Sovie bed ranges features a single-piece mattress tray with no joints (into which liquid may seep) and components are wrapped in a thermoplastic shell which kills 99.8% of E.coli and MRSA (most common hospital bacteria) over a 24-hour period.

# GUARANTEE & SERVICE



With our hassle-free White Glove delivery service, we place your furniture in individual rooms and take away all packaging, leaving you with furniture ready for use.

Over the past forty years we've built our business on providing the best products and service in our industry. We're proud of the strength of our products as well as the relationships we have with our customers.

## Giving you total peace of mind



Most of our furniture is guaranteed against **manufacturing faults for 7 years.**



Our superbly durable **Ryno® range comes with a lifetime guarantee.**

We pride ourselves on our aftercare service. Our support continues beyond the point of sale, going the extra mile to achieve complete customer satisfaction.



For exceptions, please see <https://uk.pineapplecontracts.com/guarantee>



# OUR NETWORK

Our growing global operation includes offices and partners around the world, ensuring that we can help customers wherever they are, whenever they need it.

# VISIT OUR SHOWROOM

Our UK showroom in Kent provides the opportunity to experience the comfort of our products for yourself as well as making side-by-side comparisons to ensure you make the right choice.

Feel free to bring your clients along too, have a coffee and look through materials and product options before making a decision.

## Book your visit



UK showroom in Kent  
**Call +44 (0) 1622 237830 to book your visit.**

Can't make it?



If you can't make it to see us, we can always bring furniture samples to you.  
 Our demonstration models are an ideal way to help our customers make the right choice when it comes to furniture.

# THE FULL PACKAGE

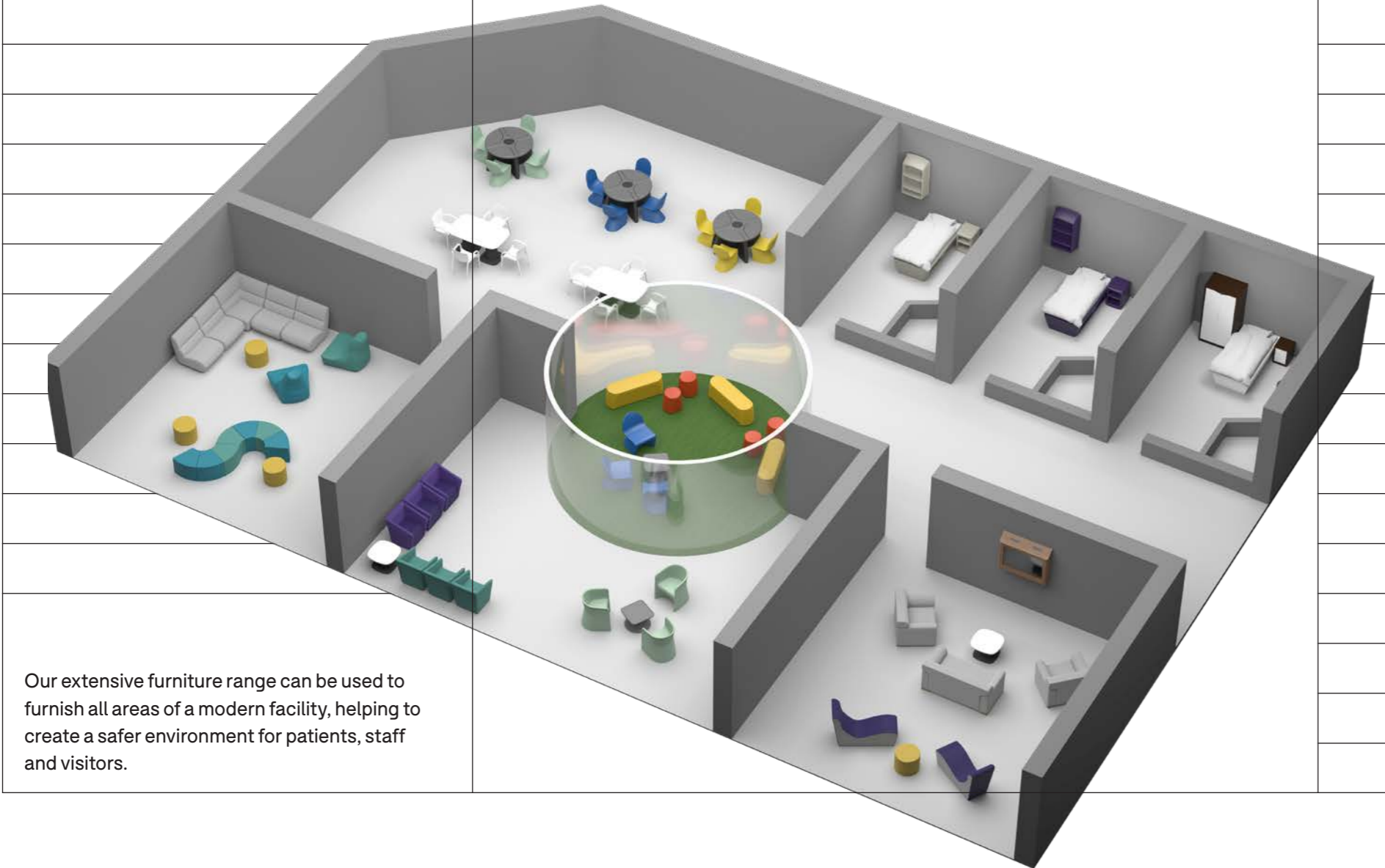

Our extensive furniture range can be used to furnish all areas of a modern facility, helping to create a safer environment for patients, staff and visitors.



**Dining area**  
Stress can be heightened during mealtimes, so our furniture is designed to minimise conflict as well as withstand outbreaks of challenging behaviour. Our Ryno® activity table weighs 140kg to prevent overturning and preserve safety.

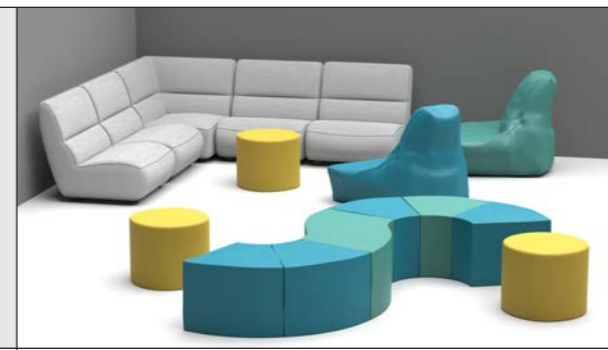

**Quiet lounge**  
Modular reinforced seating like our Snug Plus range can help to encourage social inclusion, while soft foam shapes and cosy beanbags provide a safe space for quiet reflection.



**Waiting area**  
Space efficient, easy-to-clean designs like Skye provide comfort for visitors while enabling staff to fulfil their duties more efficiently.



**Bedroom**  
Bedrooms are private spaces where round-the-clock observation may not be practical. Our safest bedroom ranges are designed to minimise ligature risks and reduce opportunities for damage.

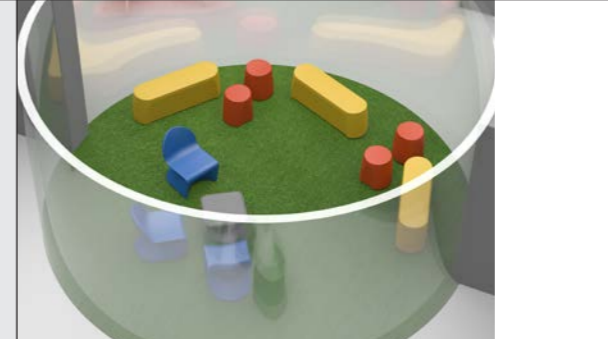

**Outdoor space**  
Products in our Ryno® range are totally water-resistant and UV stabilised, and are heavily weighted as standard, making them a safe and durable option for outdoor spaces.



**TV lounge**  
Lockable wall and floor mounted TV cabinets with durable polycarbonate screens offer protection for equipment, and there is extensive choice in our broad range of sofas.

**RYNO<sup>®</sup>**

**COMBINING**

**EXTRAORDINARY**

**RESILIENCE WITH**

**ORGANIC STYLING**

# RYNO®

Ryno products are made to the highest standards and designed to withstand the harshest treatment, representing value for money over their lifetime.

All have been created with safety in mind, with all their characteristics resulting in safer settings for users and staff.

### Weatherproof

Ryno products are totally water-resistant and UV stabilised, making them suitable for indoor and outdoor use in all weather.

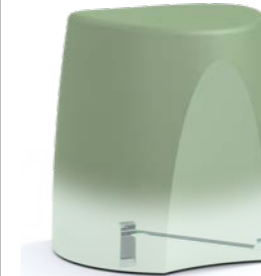

### Fixing

Using our unique hidden fastening methods, Ryno products can be secured to floors and/or walls, deterring weaponisation and reducing opportunities for concealment. left

### Lifetime guarantee

All Ryno products are covered by a lifetime guarantee against manufacturing faults, providing additional peace of mind. right



### Non-flammable

The entire Ryno range is fire-retardant, adding an extra level of safety - essential in challenging environments.



### Strength

Their one-piece construction enables Ryno products to withstand extreme treatment, with smooth curves distributing impact evenly throughout the product.



### Hygienic

Ryno products' water-resistant nature means they can easily be wiped clean, ready to be used again.



### Heavyweight

Ryno products can be heavily weighted to make them near-impossible to pick up or throw, to create safer environments.

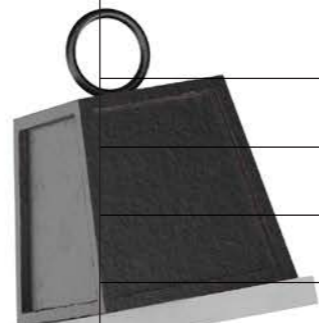
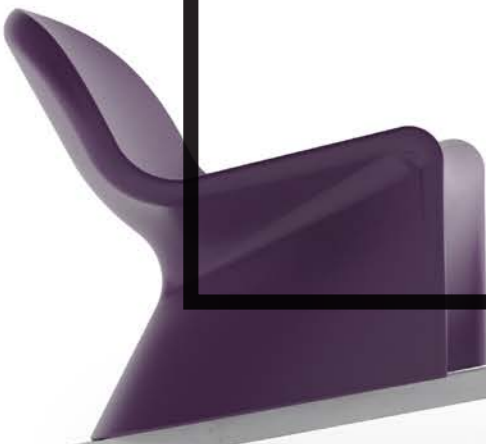



# RYNO<sup>®</sup> MATERIAL

Ryno products are manufactured from a unique polyethylene compound developed to create safe, durable products.



 <p>UV stabilised</p>	<p>A UV stabilising additive protects Ryno products against the damaging effects of the sun's rays, limiting colour fading and brittleness when used for extended periods outdoors.</p>
 <p>Flame-retardant</p>	<p>Ryno products are UL94 HB compliant due to the inherently flame-retardant properties of our polymer.</p>
 <p>100% recyclable</p>	<p>Made from 100% recyclable content, when the products reach the end of their useful life, they can be returned to us, ground down into small granules and used to create new pieces of furniture, reducing their impact on the environment.</p>

# RYNO<sup>®</sup> COLOURS

A palette of therapeutic hues.

Colour can play a key role in harmonising healthcare environments, which is why we enlisted the help of SeymourPowell, one of the world's leading design and innovation consultancies, to assist us in selecting a palette of therapeutic hues.

Whether the aim is to create a soothing and reassuring space or provide inclusive stimulation, our unique colours can help to achieve it.

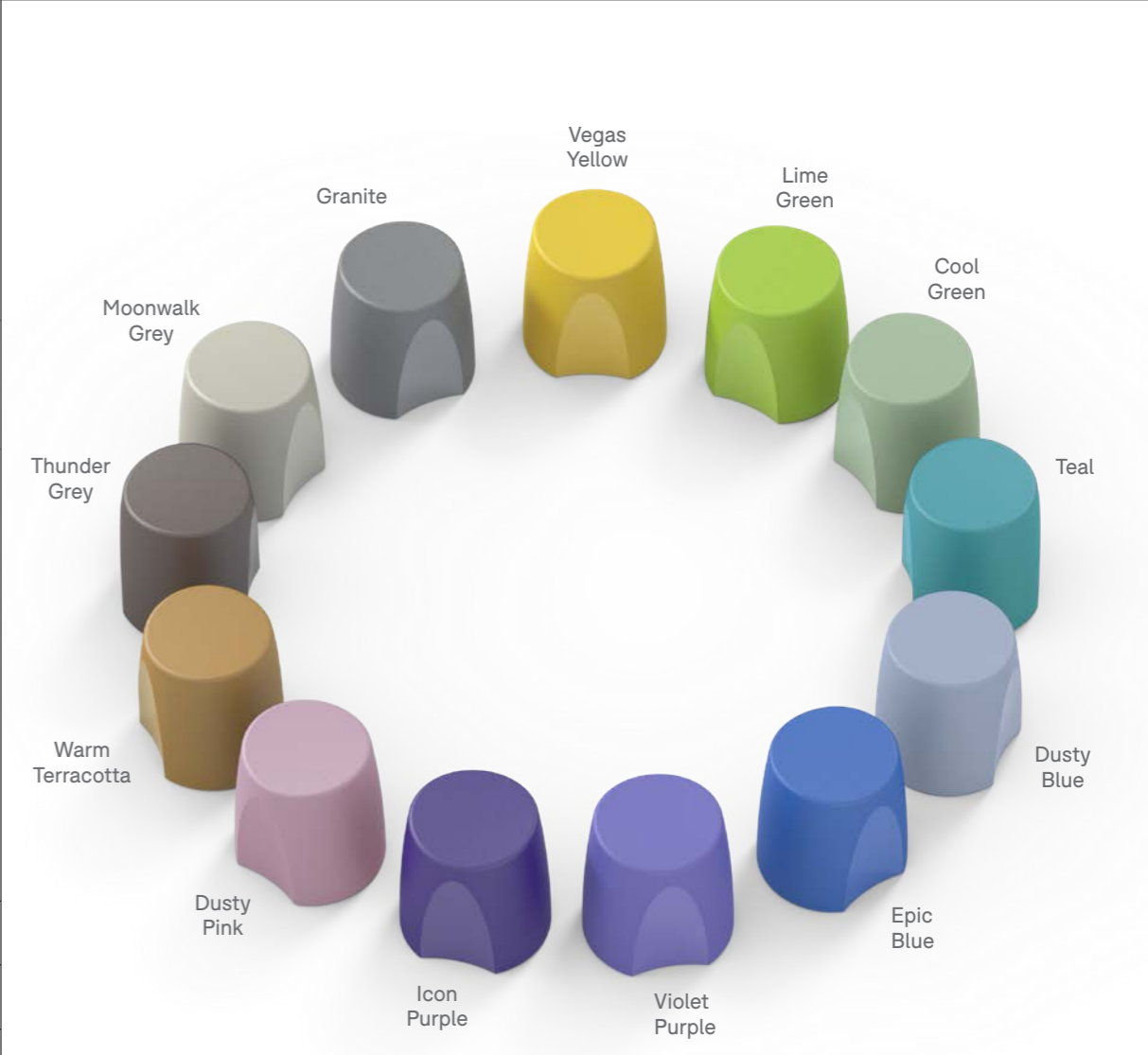
<p>seymourpowell</p>









# RYNO® ROCKER



**Ryno Rocker**  
 1RYR-00  
 867H | 761W | 992D (mm)  
 Seat height: 450mm  
 Weight: 21kg

*Rocking motion provides comfort, calm and control*

 Lifetime guarantee	 Available with added weight
 Fire retardant	 Made with recycled content
 Bedbug resistant	 Weatherproof

## KEY FEATURES

- Gentle rocking motion provides comfort and calm
- Sloped arms and low back designed to minimise ligature risks
- Hygienic wipe-clean surface

- Totally waterproof and UV stabilised material - suitable for outdoor use
- Strength and stability tested for severe contract use
- Made with recycled content, and 100% recyclable

## OPTIONS

- Weighted model (65kg)
- Anti-concealment base plate
- Anti-tip stopper
- 13 versatile shell colours

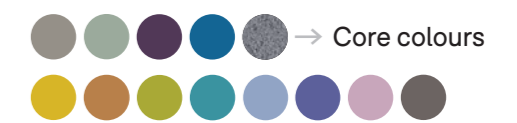





# RYNO® 2-SEATER



Seat static weight tested to  500KG



**Ryno 2-seater**  
 1RY2-123  
 810H | 1496W | 674D (mm)  
 Seat height: 435mm  
 Weight: 123kg

 Lifetime guarantee	 Weighted to deter misuse
 Fire retardant	 100% LDPE
 Weatherproof	 Floor fixed option

KEY FEATURES		OPTIONS
<ul style="list-style-type: none"> <li>→ Heavily weighted to 123kg standard to deter misuse (other weight options available)</li> <li>→ Integrated drainage channel allows water run-off</li> <li>→ Sloped arms and low back designed to minimise ligature risks</li> <li>→ Ergonomically designed to give excellent comfort</li> <li>→ Hygienic wipe-clean surface</li> </ul>	<ul style="list-style-type: none"> <li>→ Waterproof, UV stabilised material - suitable for outdoor use</li> <li>→ Strength and stability tested for severe contract use</li> </ul>	<ul style="list-style-type: none"> <li>→ Floor fixing solution</li> <li>→ Lightweight model (35kg)</li> <li>→ Anti-concealment base plate</li> <li>→ 13 versatile shell colours</li> </ul> <div style="display: flex; align-items: center;"> <div style="display: flex; gap: 5px; margin-right: 10px;"> <span style="display: inline-block; width: 10px; height: 10px; background-color: #808080; border-radius: 50%;"></span> <span style="display: inline-block; width: 10px; height: 10px; background-color: #669999; border-radius: 50%;"></span> <span style="display: inline-block; width: 10px; height: 10px; background-color: #483d8b; border-radius: 50%;"></span> <span style="display: inline-block; width: 10px; height: 10px; background-color: #0070c0; border-radius: 50%;"></span> <span style="display: inline-block; width: 10px; height: 10px; background-color: #a9a9a9; border-radius: 50%;"></span> </div> <span>→ Core colours</span> </div> <div style="display: flex; align-items: center; margin-top: 5px;"> <div style="display: flex; gap: 5px; margin-right: 10px;"> <span style="display: inline-block; width: 10px; height: 10px; background-color: #ffff00; border-radius: 50%;"></span> <span style="display: inline-block; width: 10px; height: 10px; background-color: #e67e22; border-radius: 50%;"></span> <span style="display: inline-block; width: 10px; height: 10px; background-color: #90ee90; border-radius: 50%;"></span> <span style="display: inline-block; width: 10px; height: 10px; background-color: #40e0d0; border-radius: 50%;"></span> <span style="display: inline-block; width: 10px; height: 10px; background-color: #add8e6; border-radius: 50%;"></span> <span style="display: inline-block; width: 10px; height: 10px; background-color: #4169e1; border-radius: 50%;"></span> <span style="display: inline-block; width: 10px; height: 10px; background-color: #d8bfd8; border-radius: 50%;"></span> <span style="display: inline-block; width: 10px; height: 10px; background-color: #800080; border-radius: 50%;"></span> </div> </div>
<p><i>One-piece design cannot be disassembled or weaponised</i></p>		





# RYNO<sup>®</sup> TUB CHAIR



Seat static weight tested to  450KG



**Ryno tub chair**  
 1RYU-02  
 805H | 670W | 680D (mm)  
 Seat height: 430mm  
 Weight: 82kg

 Lifetime guarantee	 Weighted to deter misuse
 Fire retardant	 100% LDPE
 Weatherproof	 Floor fixed option

KEY FEATURES		OPTIONS
<ul style="list-style-type: none"> <li>→ Heavily weighted to 82kg to deter mishandling (other weight options available)</li> <li>→ Ergonomically designed armrests to assist standing and sitting</li> <li>→ Hygienic wipe-clean material</li> </ul>	<ul style="list-style-type: none"> <li>→ Waterproof, UV stabilised material makes items suitable for outdoor use</li> <li>→ Strength and stability tested for severe contract use (BS EN 16139:2013 Level 2). Exceeded the 200,000 cycles pass mark by a further 300,000 cycles</li> </ul>	<ul style="list-style-type: none"> <li>→ Floor fixing solution</li> <li>→ Linking bracket to connect chairs</li> <li>→ Lightweight model (16kg)</li> <li>→ Available in 13 versatile colours</li> </ul> <div style="display: flex; align-items: center; gap: 5px;"> <div style="display: flex; gap: 5px;"> <span style="width: 10px; height: 10px; background-color: #808080; border-radius: 50%;"></span> <span style="width: 10px; height: 10px; background-color: #66CDAA; border-radius: 50%;"></span> <span style="width: 10px; height: 10px; background-color: #483D8B; border-radius: 50%;"></span> <span style="width: 10px; height: 10px; background-color: #008080; border-radius: 50%;"></span> <span style="width: 10px; height: 10px; background-color: #A9A9A9; border-radius: 50%;"></span> </div> <span>→ Core colours</span> </div> <div style="display: flex; gap: 5px; margin-top: 5px;"> <span style="width: 10px; height: 10px; background-color: #FFD700; border-radius: 50%;"></span> <span style="width: 10px; height: 10px; background-color: #FF8C00; border-radius: 50%;"></span> <span style="width: 10px; height: 10px; background-color: #9ACD32; border-radius: 50%;"></span> <span style="width: 10px; height: 10px; background-color: #20B2AA; border-radius: 50%;"></span> <span style="width: 10px; height: 10px; background-color: #ADD8E6; border-radius: 50%;"></span> <span style="width: 10px; height: 10px; background-color: #4169E1; border-radius: 50%;"></span> <span style="width: 10px; height: 10px; background-color: #DDA0DD; border-radius: 50%;"></span> <span style="width: 10px; height: 10px; background-color: #696969; border-radius: 50%;"></span> </div>
		<p><i>Wrap-around arms help those with reduced mobility</i></p>





# RYNO® CLUB CHAIR



Seat static weight tested to  450KG



**Ryno club chair**  
 1RYC-02  
 895H | 615W | 615D (mm)  
 Seat height: 450mm  
 Weight: 56kg

 Lifetime guarantee	 Weighted to deter misuse
 Fire retardant	 100% LDPE
 Weatherproof	 Floor fixed option

## KEY FEATURES

- Heavily weighted to 56kg as standard to deter misuse (other weight options available)
- Carefully considered curved design minimises ligature risks
- Strength and stability tested for severe contract use (BS EN 16139:2013 Level 2). Exceeded the 200,000 cycle pass mark by a further 300,000 cycles
- Hygienic wipe-clean material
- Waterproof, UV stabilised material makes items suitable for outdoor use

## OPTIONS

- Floor fixing solution
  - Linking bracket to connect chairs
  - Lightweight model (12kg)
  - 13 vibrant shell colours
-  → Core colours

*Sloping arms designed to minimise ligature risks*



# RYNO® LOUNGE

Static weight tested to 450KG



**Ryno lounge chair**  
1RYL-02  
780H | 600W | 760D (mm)  
Seat height: 420mm  
Weight: 80kg



**Ryno coffee table**  
1RYF-02  
425H | 655W | 655D (mm)  
Weight: 53kg

- Lifetime guarantee
- Weighted to deter misuse
- Fire retardant
- 100% LDPE
- Weatherproof
- Floor fixed option

KEY FEATURES		OPTIONS
<ul style="list-style-type: none"> <li>→ Heavily weighted as standard to deter misuse (other weight options available)</li> <li>→ Ergonomically designed to give excellent comfort</li> <li>→ Hygienic wipe-clean material</li> </ul>	<ul style="list-style-type: none"> <li>→ Waterproof, UV stabilised material makes non-upholstered items suitable for outdoor use</li> <li>→ Chair static weight tested for bariatric use</li> <li>→ Strength and stability tested for severe contract use</li> <li>→ 5 core colours for chairs, 1 core colour (granite) for coffee table</li> </ul>	<ul style="list-style-type: none"> <li>→ Upholstered seat and back pads</li> <li>→ Floor fixing solution</li> <li>→ Linking bracket to connect chairs</li> <li>→ Lightweight models</li> <li>→ 13 vibrant shell colours</li> </ul> <p>→ Core colours</p>
<p><i>One-piece design cannot be disassembled or weaponised</i></p>		



# RYNO<sup>®</sup> STOOL & BENCH









Static weight tested to  900KG



**Ryno stool**  
1RYS-02  
470H | 445W | 395D (mm)  
Seat height: 470mm  
Weight: 49kg



**Ryno bench**  
1RYN-02  
470H | 1400W | 395D (mm)  
Seat height: 470mm  
Weight: 88kg

 Lifetime guarantee	 Weighted to deter misuse
 Fire retardant	 100% LDPE
 Weatherproof	 Floor fixed option

KEY FEATURES		OPTIONS
<ul style="list-style-type: none"> <li>→ Heavily weighted to 49kg (stool) and 88kg (bench) as standard to deter misuse (other weight options available)</li> <li>→ Ergonomically designed to prevent stacking and to deflect rainwater</li> <li>→ Durable polyethylene one-piece construction provides excellent strength and cannot be weaponised unlike conventional seating</li> </ul>	<ul style="list-style-type: none"> <li>→ Waterproof, UV stabilised material makes items suitable for outdoor use</li> <li>→ Hygienic wipe-clean material</li> <li>→ Strength and stability tested for severe contract use (BS EN 16139:2013 Level 2). Exceeded the 200,000 cycle pass mark by a further 300,000 cycles</li> <li>→ Static weight tested to 450kg (stool) and 900kg (bench)</li> </ul>	<ul style="list-style-type: none"> <li>→ Patented invisible floor fixing method</li> <li>→ Lightweight models</li> <li>→ 13 vibrant shell colours</li> </ul> <div style="display: flex; align-items: center; gap: 10px;"> <div style="display: flex; gap: 5px;"> <span style="width: 15px; height: 15px; background-color: #666; border-radius: 50%;"></span> <span style="width: 15px; height: 15px; background-color: #444; border-radius: 50%;"></span> <span style="width: 15px; height: 15px; background-color: #333; border-radius: 50%;"></span> <span style="width: 15px; height: 15px; background-color: #222; border-radius: 50%;"></span> <span style="width: 15px; height: 15px; background-color: #111; border-radius: 50%;"></span> </div> <span>→ Core colours</span> </div> <div style="display: flex; gap: 10px; margin-top: 5px;"> <span style="width: 15px; height: 15px; background-color: #FFD700; border-radius: 50%;"></span> <span style="width: 15px; height: 15px; background-color: #FF8C00; border-radius: 50%;"></span> <span style="width: 15px; height: 15px; background-color: #90EE90; border-radius: 50%;"></span> <span style="width: 15px; height: 15px; background-color: #40E0D0; border-radius: 50%;"></span> <span style="width: 15px; height: 15px; background-color: #ADD8E6; border-radius: 50%;"></span> <span style="width: 15px; height: 15px; background-color: #4169E1; border-radius: 50%;"></span> <span style="width: 15px; height: 15px; background-color: #DDA0DD; border-radius: 50%;"></span> <span style="width: 15px; height: 15px; background-color: #808080; border-radius: 50%;"></span> </div>
		<p><i>Provides peace of mind both indoors and out</i></p>



# RYNO® DINING CHAIR





Seat static weight tested to 



**Ryno dining chair**  
 1RYD-02  
 880H | 500W | 620D (mm)  
 Seat height: 450mm  
 Weight: 54kg



**Ryno children's chair**  
 1RYCD-01  
 750H | 420W | 525D (mm)  
 Seat height: 380mm  
 Weight: 30kg

 Lifetime guarantee	 Weighted to deter misuse
 Fire retardant	 100% LDPE
 Weatherproof	 Floor fixed option

KEY FEATURES		OPTIONS
<ul style="list-style-type: none"> <li>→ Heavily weighted to 54kg as standard to deter misuse (other weight options available)</li> <li>→ Ergonomically designed for comfort</li> <li>→ Hygienic wipe-clean material</li> </ul>	<ul style="list-style-type: none"> <li>→ Waterproof, UV stabilised material makes non-upholstered items suitable for outdoor use</li> <li>→ Strength and stability tested for severe contract use (BS EN 16139:2013 Level 2). Exceeded the 200,000 cycle pass mark by a further 300,000 cycles</li> </ul>	<ul style="list-style-type: none"> <li>→ Upholstered seat and back pads</li> <li>→ Floor fixing solution</li> <li>→ Linking bracket to connect chairs</li> <li>→ Lightweight model (10kg)</li> <li>→ 13 vibrant shell colours</li> </ul> <div style="display: flex; align-items: center;"> <div style="display: flex; gap: 5px; margin-right: 10px;"> <span style="background-color: #808080; width: 15px; height: 15px; border-radius: 50%;"></span> <span style="background-color: #669999; width: 15px; height: 15px; border-radius: 50%;"></span> <span style="background-color: #444444; width: 15px; height: 15px; border-radius: 50%;"></span> <span style="background-color: #0070C0; width: 15px; height: 15px; border-radius: 50%;"></span> <span style="background-color: #A9A9A9; width: 15px; height: 15px; border-radius: 50%;"></span> </div> <span>→ Core colours</span> </div> <div style="display: flex; gap: 5px; margin-top: 5px;"> <span style="background-color: #FFD700; width: 15px; height: 15px; border-radius: 50%;"></span> <span style="background-color: #FF8C00; width: 15px; height: 15px; border-radius: 50%;"></span> <span style="background-color: #9ACD32; width: 15px; height: 15px; border-radius: 50%;"></span> <span style="background-color: #40E0D0; width: 15px; height: 15px; border-radius: 50%;"></span> <span style="background-color: #ADD8E6; width: 15px; height: 15px; border-radius: 50%;"></span> <span style="background-color: #4169E1; width: 15px; height: 15px; border-radius: 50%;"></span> <span style="background-color: #9370DB; width: 15px; height: 15px; border-radius: 50%;"></span> <span style="background-color: #808080; width: 15px; height: 15px; border-radius: 50%;"></span> </div>
		<p><i>One-piece design cannot be disassembled or weaponised</i></p>





# RYNO® PEDESTAL TABLE





Static weight tested to  500KG



**Ryno pedestal table**  
 1RYPT-120  
 760H | 1050ø (mm)  
 Weight: 118kg

-   
Weighted to deter misuse (120kg)
-   
Lifetime guarantee
-   
Fire retardant
-   
100% LDPE
-   
Weatherproof
-   
Floor fixed option

KEY FEATURES 		OPTIONS
<ul style="list-style-type: none"> <li>→ Durable polyethylene construction provides excellent strength and cannot be weaponised unlike conventional tables</li> <li>→ Waterproof and UV stabilised material – ideal for outdoor use</li> <li>→ Durable solid-grade laminate table top</li> <li>→ Wheelchair accessible design</li> <li>→ Hygienic wipe-clean material</li> </ul>	<ul style="list-style-type: none"> <li>→ Material compliant with flammability standards UL94 HB &amp; BS 5852:2006</li> <li>→ Strength and durability tested for severe contract use, including an additional 500kg static load test</li> </ul>	<ul style="list-style-type: none"> <li>→ Anti-tamper floor fixed option (30kg)</li> <li>→ Available in 1 core colour (Moonwalk Grey) and 12 other colours (minimum order quantity 12 units per colour)</li> </ul> <div style="margin-top: 10px;">  ← Core colour                 </div> <div style="margin-top: 10px;">  </div>



# RYNO® DINING TABLES

Static weight tested to  500KG



**Ryno dining table with moulded top**  
 IRYDT-103-DT  
 750H | 1250W | 1250D  
 Weight: 99kg



**Ryno activity table with flat laminate top**  
 1RYAT-138  
 750H | 1320W | 1320D (mm)  
 Weight: 140kg

-   
Weighted to deter misuse
-   
Lifetime guarantee
-   
Fire retardant
-   
100% LDPE
-   
Weatherproof
-   
Floor fixed option
-   
Weighted to deter misuse
-   
Lifetime guarantee
-   
Fire retardant
-   
Floor fixed option
-   
Not weatherproof

KEY FEATURES		OPTIONS
<ul style="list-style-type: none"> <li>→ Heavily weighted to deter misuse (other weight options available)</li> <li>→ Cruciform base design prevents conflict and passing of contraband</li> <li>→ Hygienic wipe-clean material</li> </ul>	<ul style="list-style-type: none"> <li>→ Moulded top table is waterproof and UV stabilised, making it suitable for outdoor use</li> <li>→ Activity top table (including games top) features a high-pressure laminate top which is not suitable for outdoor use</li> <li>→ Strength and stability tested for severe contract use (BS EN 15372:2008 Level 3 6.4) to 300,000 cycles</li> </ul>	<ul style="list-style-type: none"> <li>→ Floor fixing solution</li> <li>→ Lightweight models</li> <li>→ Choice of 5 colours for activity table top (Grey PU edging on all options)</li> <li style="text-align: center;">  → Core colour                 </li> <li>→ Games top</li> </ul>





# RYNO® BEDROOM



**Ryno chest with 3 compartments**  
1RYOC  
735H | 698W | 507D (mm)  
Weight: 24kg



**Ryno desk**  
Code: 1RYOD  
735H | 698W | 507D (mm)  
Weight: 20kg



**Ryno bedside with 2 compartments**  
1RYOB  
595H | 400W | 380D (mm)  
Weight: 13kg



**Ryno wall shelf with 3 compartments**  
1RYOK  
1200H | 699W | 313D (mm)  
Weight: 20kg



**Ryno mini wall shelf**  
1RYOKM  
433H | 214W | 140D (mm)  
Weight: 2kg

## KEY FEATURES

- One-piece design makes products water-resistant and prevents concealment of contraband
- Reduced-ligature design features
- Safely rounded corners
- Organic textures help to create an environment that fosters recovery
- Hygienic wipe-clean material

## OPTIONS

- Patented invisible floor fixing method
- Available in 1 core colour (Moonwalk Grey) and 12 other colours (minimum order quantity 5 units per colour)

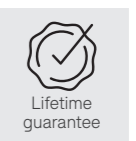

Lifetime guarantee

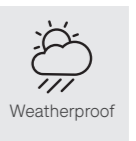

Weatherproof



Fire retardant



Floor fixed

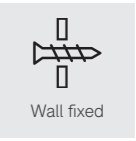

Wall fixed

*Extremely durable one-piece construction*

UK Registered Design No. 6059838 (chest), 6059840 (desk), 6059836 (bedside), 6059843 (wall shelf)







# RYNO<sup>®</sup> OCEANGREEN

Helping to keep our oceans clean

Abandoned or lost fishing equipment accounts for around 10% of the plastics that end up in our oceans.<sup>1</sup>

“Ghost nets” like these can be harmful to sea life with fish, birds, crabs and other species becoming tangled in them and attracting larger animals like dolphins and whales which can also become trapped. They can also cause damage to sea beds and coral reefs by becoming snagged and shading them from sunlight.

By collecting these nets before they reach our oceans, and using them to manufacture our products, we’re minimising the harm abandoned nets can cause to our oceans.

By using *recycled* materials to manufacture *recyclable* products, we’re creating a sustainable supply chain.

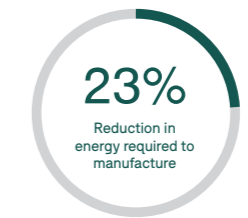

By reducing the amount of virgin material used to produce our furniture, we reduce the energy consumption by 23%.

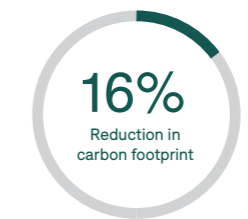

We’re assessing all of our products for carbon reduction opportunities. The OceanGreen material offers a 16% reduction in carbon emissions.



1. [https://www.greenpeace.org/static/planet4-international-stateless/2019/11/8f290a4f-ghostgearfishingreport2019\\_greenpeace.pdf](https://www.greenpeace.org/static/planet4-international-stateless/2019/11/8f290a4f-ghostgearfishingreport2019_greenpeace.pdf)

**SOFT SEATING**

**BLENDING DURABLE**

**SEATING WITH**

**COMFORTABLE**

**UPHOLSTERY**







# SIGMA PLUS



Seat static weight tested to 



**Sigma Plus chair**  
1SIGP1-900  
800H | 800W | 708D (mm)  
Seat Height: 440mm  
Weight: 36kg



**Sigma Plus 2-seater**  
1SIGP2-900  
800H | 1350W | 708D (mm)  
Seat Height: 440mm  
Weight: 51kg

KEY FEATURES	OPTIONS	
<ul style="list-style-type: none"> <li>→ Wrap-around design of the seat back provides comfort and support</li> <li>→ Designed with minimal upholstery gaps to prevent concealment</li> <li>→ Compact footprint helps you make the most of your available space</li> <li>→ Heavyweight to deter mishandling</li> </ul>	<ul style="list-style-type: none"> <li>→ Also available as standard model</li> <li>→ Wide choice of water-resistant upholstery</li> </ul> 	<p><i>Zero-depth seams designed to prevent concealment</i></p>



# SKYE PLUS





Seat static weight tested to 



**Skye Plus chair**  
1SKYP1-400  
825H | 735W | 785D (mm)  
Seat height 470mm  
Weight: 40kg



**Skye Plus 2-seater**  
1SKYP2-400  
825H | 1250W | 785D (mm)  
Seat height 470mm  
Weight: 58kg

KEY FEATURES	OPTIONS	
<ul style="list-style-type: none"> <li>→ Strong plywood frame with additional reinforcement ensures maximum strength</li> <li>→ Tapered base design to make standing easier</li> <li>→ Compact design and small footprint maximises space</li> <li>→ Heavyweight to deter mishandling</li> </ul>	<ul style="list-style-type: none"> <li>→ Also available as standard model</li> <li>→ Plinth base</li> <li>→ Wide choice of water-resistant upholstery</li> </ul> 	<p><i>Optional plinth base prevents dust and dirt from gathering underneath</i></p>



# TEMPO PLUS



Seat static weight tested to 



**Tempo Plus chair**  
1TP1-400  
735H | 715W | 730D (mm)  
Seat height 400mm  
Weight: 38kg



**Tempo Plus 2-seater**  
1TP2-400  
735H | 1400W | 730D (mm)  
Seat height 400mm  
Weight: 76kg

KEY FEATURES
→ Strong timber frame with additional reinforcement ensures maximum strength
→ Enclosed base minimises concealment
→ Fixed seat cushion prevents misuse
→ Heavyweight to deter mishandling

OPTIONS
→ Also available as standard model
→ Removable seat cushion for easy cleaning
→ Wide choice of water-resistant upholstery

*Comfortable back support with added reinforcement*





# PURL PLUS



Seat static weight tested to 200KG



**Purl Plus low back armchair**  
 1PULP1-400  
 870H | 700W | 780D (mm)  
 Seat Height: 480mm  
 Weight: 38kg



**Purl Plus high back armchair**  
 1PUHP1-400  
 1070H | 700W | 780D (mm)  
 Seat Height: 480mm  
 Weight: 41kg



**Purl Plus low back 2-seater**  
 1PULP2-400  
 870H | 1190W | 780D (mm)  
 Seat Height: 480mm  
 Weight: 52.5kg



**Purl Plus high back 2-seater**  
 1PUHP2-400  
 1070H | 1190W | 780D (mm)  
 Seat Height: 480mm  
 Weight: 56.5kg

*Reinforcement and fully enclosed base*

KEY FEATURES	OPTIONS	
→ Standard reinforcement provides strength and durability	→ Also available as standard model	
→ Wrap-around design of the seat back provides comfort and support	→ Available with chrome or natural wood feet	
→ 480mm seat height designed to help those with reduced mobility	→ Wide choice of water-resistant upholstery	
→ Fixed seat cushion to prevent misuse		



# ZEN PLUS



Seat static weight tested to  500KG



**Zen Plus chair**  
1ZENP1-400  
1000H | 600W | 1485D (mm)  
Weight: 61.5kg



**Zen Plus duo chair**  
1ZENDP-400  
1000H | 600W | 990D (mm)  
Weight: 41.5kg



**Zen Plus armchair**  
1ZEN1-500  
1000H | 730W | 1100D (mm)  
Weight: 50kg



**Zen Plus duo footstool**  
1ZENDSP-400  
450H | 540W | 545D (mm)  
Weight: 23kg

KEY FEATURES	OPTIONS	
→ Plywood reinforcement, including a fully enclosed base to prevent concealment	→ Also available as standard model	<i>Perfect for areas of calm, rest and relaxation</i>
→ Designed to prevent rapid standing motion, creating a safer and calmer environment	→ Dual fabrics for added personalisation	
→ Smoothly reclined shape prevents pressure points and provides exceptional comfort	→ Wide choice of water-resistant upholstery	
→ Weighted to deter mishandling		

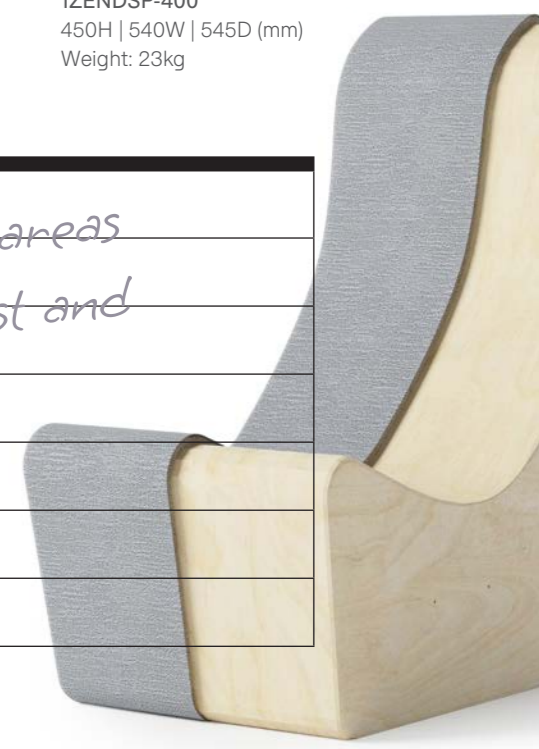



# ZEN PLUS ROCKER

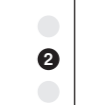

Seat static weight tested to 



**Zen Plus rocker**  
 1ZENRP1-900  
 1015H | 660W | 1115D (mm)  
 Weight: 59kg

KEY FEATURES	OPTIONS	
<ul style="list-style-type: none"> <li>→ Fluid rocking motion provides a source of focus and calm</li> <li>→ Smoothly reclined shape prevents pressure points and provides comfort</li> <li>→ Designed with minimal upholstery gaps to prevent concealment</li> <li>→ Plywood reinforcement for added durability</li> <li>→ Security screws and inaccessible staples to prevent tampering</li> </ul>	<ul style="list-style-type: none"> <li>→ Dual fabrics for added personalisation</li> <li>→ Wide choice of water-resistant upholstery</li> </ul> 	<p style="text-align: center;"><i>Provides a source of focus and calm</i></p>



# DOORNE PLUS



Doorne Plus single  
1DRMP1-400  
450H | 450W | 450D (mm)  
Seat Height: 450mm  
Weight: 24kg



Doorne Plus double  
1DRMP2-400  
450H | 900W | 450D (mm)  
Seat Height: 450mm  
Weight: 45kg



Doorne Plus 45° curved  
1DRMP3-400  
450H | 730W | 450D (mm)  
Seat Height: 450mm  
Weight: 26kg

## KEY FEATURES

- Versatile modular design helps you make the most of your space
- Can be used individually or in multiples
- Plinth base to prevent dust and dirt gathering underneath
- Furniture glides prevent damage to floor when being moved

## OPTIONS

- Also available without added weight
- Wide choice of water-resistant upholstery



*Plinth base prevents dust and dirt from gathering underneath*



# SNUG PLUS



Seat static weight tested to  500KG



**Snug Plus chair**  
1SGP1-900  
890H | 940W | 1060D (mm)  
Seat height: 450mm  
Weight: 40kg



**Snug Plus footstool**  
1SGPS-900  
400H | 900W | 900D (mm)  
Weight: 26.5kg



**Snug Plus corner chair**  
1SGPC1-900  
890H | 1060W | 1060D (mm)  
Seat height: 450mm  
Weight: 53kg

KEY FEATURES	OPTIONS	
→ Plywood reinforcement, including a fully enclosed base to prevent concealment	→ Also available as standard model	
→ Zero-depth seams to prevent concealment	→ Wide choice of water-resistant upholstery	
→ Versatile modular design helps you make the most of your space		<i>Combines sumptuous comfort with durable reinforcement</i>
→ Promotes social inclusion		
→ Low overall height provides clearer sight lines for staff		







# OHIO PLUS



Seat static weight tested to 



**Ohio Plus chair**  
1OP1-400  
860H | 580W | 860D (mm)  
Seat height: 480mm  
Weight: 38kg





**Ohio Plus curved - wide front**  
1OPC1-500  
860H | 1030W | 860D (mm)  
Seat height: 480mm  
Weight: 25kg



**Ohio Plus curved - narrow front**  
1OPC1-400  
860H | 1030W | 860D (mm)  
Seat height: 480mm  
Weight: 27.5kg



**Ohio Plus coffee table**  
1OPF-400  
420H | 830W | 830D (mm)  
Weight: 34kg

KEY FEATURES	OPTIONS	
<ul style="list-style-type: none"> <li>→ Plywood reinforcement, including a fully enclosed base to prevent concealment</li> <li>→ Versatile modular design helps you make the most of your space</li> <li>→ Reduced-ligature ski feet protect flooring and facilitate movement</li> </ul>	<ul style="list-style-type: none"> <li>→ Also available as standard model</li> <li>→ Also available with open ski feet</li> <li>→ Linking bracket to connect items</li> <li>→ Wide choice of water-resistant upholstery</li> </ul> 	

# SNUG PLUS CONFIGURATIONS

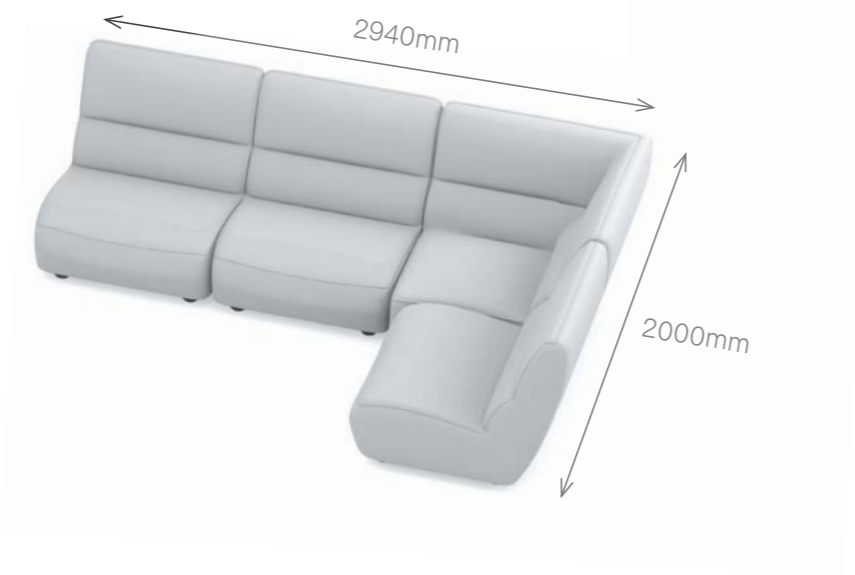
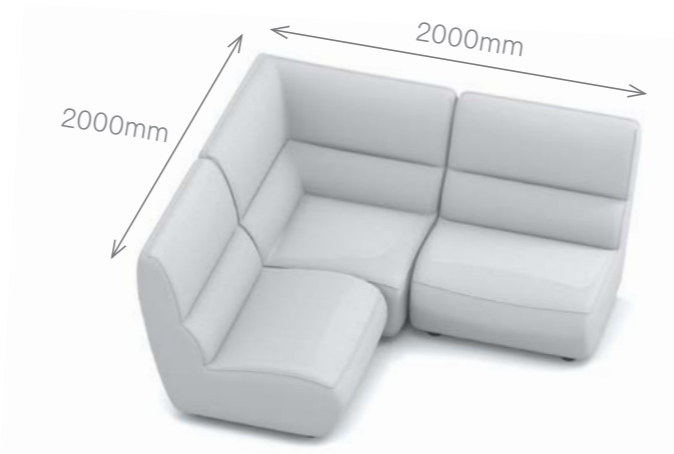
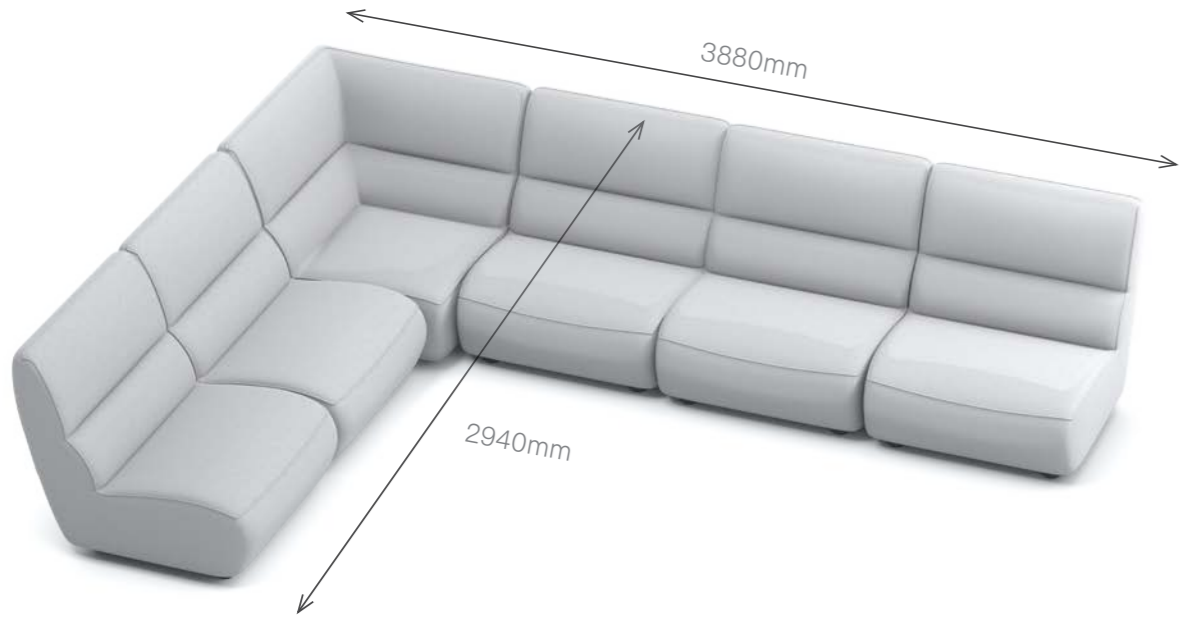

# OHIO PLUS CONFIGURATIONS

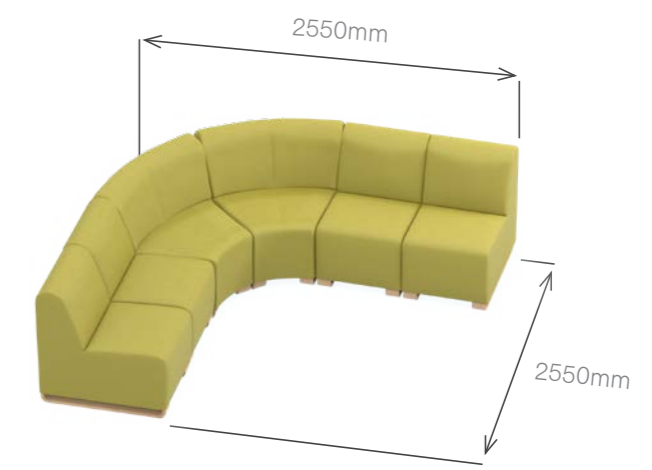
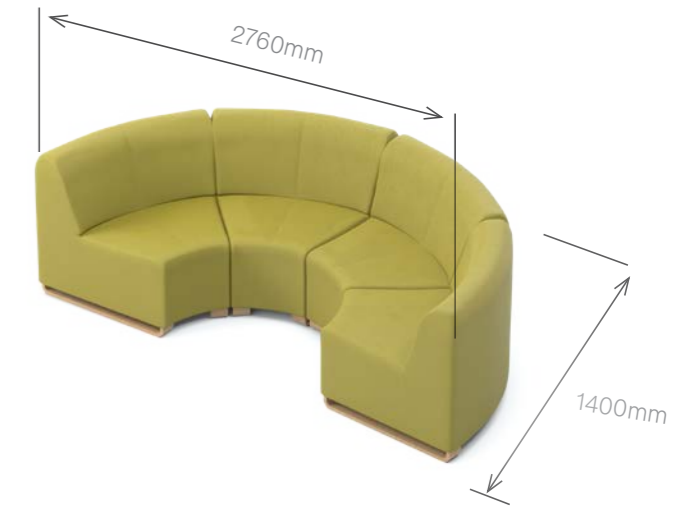





# MAGNA PLUS



Seat static weight tested to 



**Magna Plus chair**  
1MG1-900  
790H | 944W | 790D (mm)  
Seat height: 447mm



**Magna Plus 3-seater**  
1MG3-900  
790H | 1984W | 790D (mm)  
Seat height: 447mm



**Magna Plus 2-seater**  
1MG2-900  
790H | 1454W | 790D (mm)  
Seat height: 447mm

KEY FEATURES	OPTIONS	
<ul style="list-style-type: none"> <li>→ Plywood reinforcement for added strength</li> <li>→ 'Zero depth' seams minimise opportunities for concealing medication or contraband</li> <li>→ Fully enclosed base to prevent concealment</li> <li>→ Fixed seat and back cushions to prevent misuse</li> </ul>	<ul style="list-style-type: none"> <li>→ Zero depth seams to prevent concealment</li> <li>→ Clear-vision base to aid inspection</li> <li>→ Wide choice of water-resistant upholstery</li> </ul> 	<p><i>Reinforced sofa with optional anti-concealment seams</i></p>





# QUADRA PLUS



Seat static weight tested to  200KG



**Quadra Plus chair**  
1QA1-400  
770H | 960W | 890D (mm)  
Seat height: 455mm



**Quadra Plus 3-seater**  
1QA3-400  
770H | 1940W | 890D (mm)  
Seat height: 455mm



**Quadra Plus 2-seater**  
1QA2-400  
770H | 1445W | 890D (mm)  
Seat height: 455mm

KEY FEATURES	OPTIONS
<ul style="list-style-type: none"> <li>→ Plywood reinforcement for added strength</li> <li>→ Fully enclosed base to prevent concealment</li> <li>→ Removable seat cushions for easy cleaning</li> </ul>	<ul style="list-style-type: none"> <li>→ Clear-vision base to aid inspection</li> <li>→ Wide choice of water-resistant upholstery</li> </ul> 

*Reinforced options makes this range as strong as you need it to be*

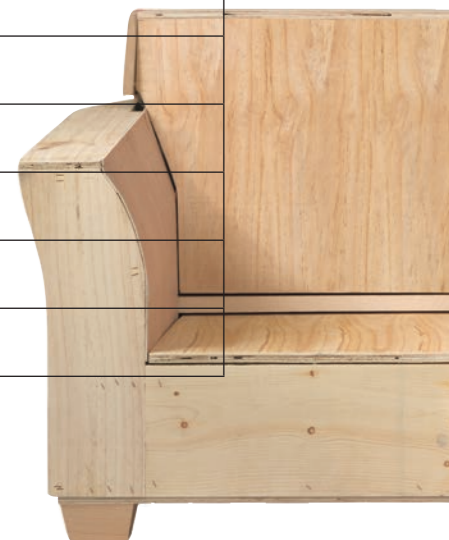



# ORR PLUS



Seat static weight tested to  500KG



**Orr Plus chair**  
1OR1-400  
850H | 710W | 870D (mm)  
Seat height: 440mm



**Orr Plus 3-seater**  
1OR3-400  
850H | 1770W | 870D (mm)  
Seat height: 440mm



**Orr Plus 2-seater**  
1OR2-400  
850H | 1240W | 870D (mm)  
Seat height: 440mm



**Orr Plus bariatric chair**  
1ORB1-400  
850H | 900W | 870D (mm)  
Seat height: 440mm

KEY FEATURES	OPTIONS	
→ Plywood reinforcement for added strength	→ Clear-vision base to aid inspection	
→ Fully enclosed base to prevent concealment	→ Wide choice of water-resistant upholstery	
→ Slim arm maximises seating capacity		
→ Removable seat and back cushions for easy cleaning		

*Reinforced options makes this range as strong as you need it to be*





# ORR CORNER PLUS

2

Seat static weight tested to 



**Orr Corner unit 2-seater left arm and 2-seater right arm**  
 1OC2L2R-400  
 850H | 2070W | 2070D (mm)  
 Seat height: 440mm



**Orr Corner unit 2-seater left arm and 3-seater right arm**  
 1OC2L3R-400  
 850H | 2590W | 2070D (mm)  
 Seat height: 440mm



**Orr Corner unit 3-seater left arm and 2-seater right arm**  
 1OC3L2R-400  
 850H | 2070W | 2590D (mm)  
 Seat height: 440mm



**Orr Corner unit 3-seater left arm and 3-seater right arm**  
 OC3L3R-400  
 850H | 2590W | 2590D (mm)  
 Seat height: 440mm

KEY FEATURES	OPTIONS	
→ Versatile layouts to suit your space	→ Clear-vision base to aid inspection	
→ Plywood reinforcement for added strength	→ Wide choice of water-resistant upholstery	
→ Fully enclosed base to prevent concealment		
→ Slim arm maximises seating capacity	<i>Reinforced options makes this range as strong as you need it to be</i>	
→ Removable seat and back cushions for easy cleaning		





# RUBUS PLUS



Seat static weight tested to 



**Rubus Plus chair**  
1RS1-900  
890H | 1170W | 940D (mm)  
Seat height: 445mm



**Rubus Plus 3-seater**  
1RS3-900  
890H | 2000W | 940D (mm)  
Seat height: 445mm



**Rubus Plus 2-seater**  
1RS2-900  
890H | 1720W | 940D (mm)  
Seat height: 445mm

## KEY FEATURES

- Plywood reinforcement for added strength and durability
- Anti-concealment seams and fully enclosed base to prevent concealment
- Stylish chrome feet

## OPTIONS

- Clear-vision base to aid inspection
- Wide choice of water-resistant upholstery



*Reinforced options makes this range as strong as you need it to be*

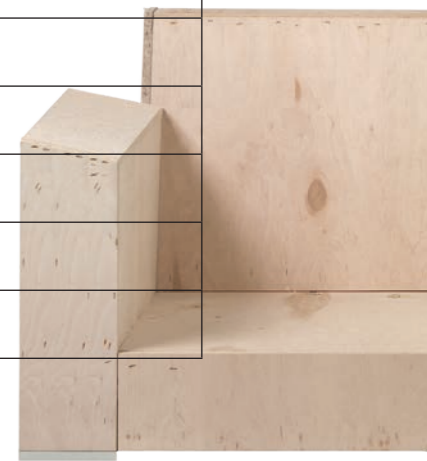





# HARRIER AND OSPREY PLUS



Seat static weight tested to  200KG



**Harrier Plus chair**  
1HI1-400  
870H | 850W | 950D (mm)  
Seat height: 460mm



**Harrier Plus 2-seater**  
1HI2-400  
870H | 1390W | 950D (mm)  
Seat height: 460mm



**Harrier Plus 3-seater**  
1HI3-400  
870H | 1920W | 950D (mm)  
Seat height: 460mm



**Osprey Plus chair**  
1OY1-400  
900H | 880W | 950D (mm)  
Seat height: 460mm



**Osprey Plus 2-seater**  
1OY2-400  
900H | 1420W | 950D (mm)  
Seat height: 460mm



**Osprey Plus 3-seater**  
1OY3-400  
900H | 1950W | 950D (mm)  
Seat height: 460mm

KEY FEATURES - HARRIER	KEY FEATURES - OSPREY	OPTIONS
<ul style="list-style-type: none"> <li>→ Plywood reinforcement for added strength</li> <li>→ Fully enclosed base to prevent concealment</li> <li>→ Scroll arm design with flared sides</li> <li>→ Removable seat cushions for easy cleaning</li> </ul>	<ul style="list-style-type: none"> <li>→ Plywood reinforcement for added strength</li> <li>→ Fully enclosed base to prevent concealment</li> <li>→ Scroll arm design with flared sides</li> <li>→ Removable seat and back cushions for easy cleaning</li> </ul>	<ul style="list-style-type: none"> <li>→ Clear-vision base to aid inspection</li> <li>→ Wide choice of water-resistant upholstery</li> </ul> 

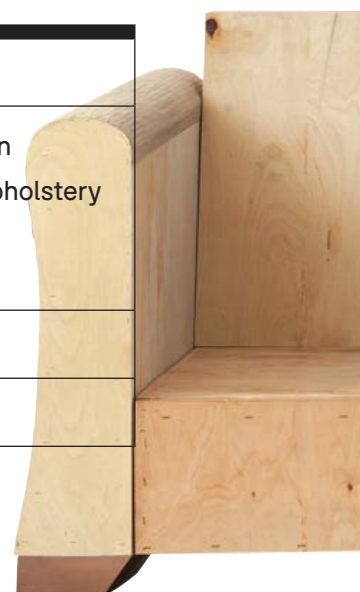



# ARUBA



Seat static weight tested to



**Aruba chair**  
1AA1-100  
880H | 960W | 920D (mm)  
Seat height: 490mm



**Aruba 3-seater**  
1AA3-100  
880H | 2020W | 920D (mm)  
Seat height: 490mm



**Aruba 2-seater**  
1AA2-100  
880H | 1490W | 920D (mm)  
Seat height: 490mm

KEY FEATURES	OPTIONS	
<ul style="list-style-type: none"> <li>→ Smooth rounded arms</li> <li>→ Removable seat and back cushions for easy cleaning</li> </ul>	<ul style="list-style-type: none"> <li>→ Available with Natural and Walnut feet</li> <li>→ Wide choice of water-resistant upholstery</li> </ul>	<p><i>Available with reinforced seat platform for added durability</i></p>





# LIBERTY



Seat static weight tested to 





**Liberty chair**  
1LY1-300  
1040H | 850W | 900D (mm)  
Seat height: 480mm  
Weight: 73.5kg



**Liberty 3-seater**  
1LY3-300  
1040H | 2080W | 900D (mm)  
Seat height: 480mm  
Weight: 143.5kg



**Liberty 2-seater**  
1LY2-300  
1040H | 1540W | 900D (mm)  
Seat height: 480mm  
Weight: 110kg

KEY FEATURES	OPTIONS	
<ul style="list-style-type: none"> <li>→ Plywood reinforcement for strength</li> <li>→ Removable seat allows thorough inspection and cleaning</li> <li>→ Seat and back are securely locked in place during use</li> </ul>	<p>→ Wide choice of water-resistant upholstery</p> 	<p><i>Removable seat allows thorough inspection and cleaning</i></p> 



# CODA

Seat static weight tested to



**Coda armchair**  
1CDA1-900  
815H | 945W | 800D (mm)  
Seat height: 450mm



**Coda 3-seater**  
1CDA3-900  
815H | 2000W | 800D (mm)  
Seat height: 450mm



**Coda 2-seater**  
1CDA2-900  
815H | 1545W | 800D (mm)  
Seat height: 450mm

*Space between cushions to prevent concealment*

## KEY FEATURES

- 40mm space between cushions to prevent concealment and make inspection safer
- Unlike conventional sofas, there are no dirt-traps and can be thoroughly cleaned
- Strong and durable steel frame which is resistant to moisture from cleaning
- Plywood reinforcement for strength

## OPTIONS

- Available in two-tone upholstered finish
- Wide choice of water-resistant upholstery





# REEF DE-ESCALATION



Seat static weight tested to  200KG



**Reef 3-seater**  
 1RF3-400  
 900H | 1885W | 930D (mm)  
 Seat height: 450mm

KEY FEATURES	OPTIONS	
<ul style="list-style-type: none"> <li>→ Armless design assists de-escalation practices and reduces likelihood of damage</li> <li>→ Full plywood reinforcement for extra strength and weight</li> </ul>	<ul style="list-style-type: none"> <li>→ Wide choice of water-resistant upholstery</li> </ul> 	<p><i>Armless design assists de-escalation</i></p>

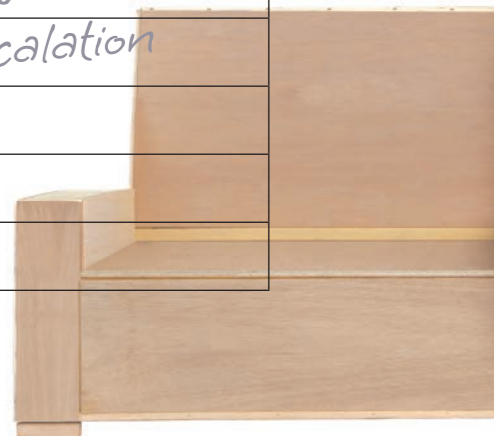

## DE-ESCALATION COUCH

# JAK

In situations where a patient is in severe distress and initial verbal de-escalation techniques have proven ineffective, physical intervention may be used as a last resort to prevent the patient causing harm to themselves and others.

During physical intervention staff will aim to restrict the patient's movements using the minimum force required, maintaining patient dignity. These interventions can be physically demanding, presenting risk of injury.

Through live service evaluations with clinical professionals, every angle of this couch has been optimised to support safer de-escalation practices for patients and staff alike.

### ANGLED DESIGN



- Outer seats angled at 33° to allow closer patient engagement, aiding verbal de-escalation.
- Tapered footwell aides staff in safe de-escalation practices.

### LOWERED CENTRAL SEAT

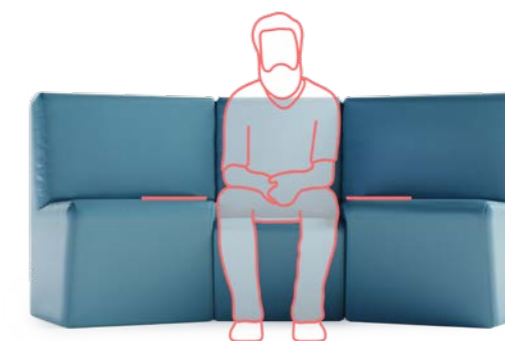

- Helps to control lateral movement.
- Gives staff superior leg control.

### UPRIGHT SEATING POSITION



- Preserves patient dignity.
- Supports staff in de-escalation processes.



Evidence-based design providing support when it's needed most.



Beneficial for all levels of intervention.

Designed and developed in association with:

Andy Johnston Associates

Andy Johnston is a Clinical Director and independent mental health consultant with over 32 years of experience in mental health services including conflict resolution and physical intervention.

*"Staff body positions are supported throughout a seated intervention - great to see such a design"*

Physical intervention specialist



## JAK DE-ESCALATION COUCH



**JAK de-escalation couch**  
 1DES3-100  
 905H | 2020W | 875D (mm)  
 Mid. Seat Height: 400mm  
 Outer Seat Height: 465mm  
 Weight: 70kg

KEY FEATURES	OPTIONS	
<ul style="list-style-type: none"> <li>→ Outer seats angled inwards at 33° to provide staff back support</li> <li>→ Lowered central seat and tapered footwell aids staff in safe de-escalation practices</li> <li>→ Designed in conjunction with physical intervention specialists</li> </ul>	<p>→ Wide choice of water-resistant upholstery</p> 	<p><i>Designed to make physical intervention as safe and dignified as possible</i></p>



# SEAL



Seal is made from soft-tec™ - a two-part molded polyurethane material which combines soft comfort with resistance and durability. The soft core in flexible polyurethane foam is bonded to an external water-resistant polyurethane skin. [below](#)

Made without seams or gaps, Seal is designed to reduce concealment risks in challenging environments.





# SEAL ANTI-CONCEALMENT



Seat static weight tested to



**Seal anti-concealment chair**  
 1SAS1-70  
 840H | 750W | 700D (mm)  
 Weight: 70kg



**Seal anti-concealment 2-seater**  
 1SAS2-90  
 840H | 1500W | 700D (mm)  
 Weight: 90kg

*Designed without seams to prevent concealment and provide water resistance*

KEY FEATURES	OPTIONS	
<ul style="list-style-type: none"> <li>→ Designed without seams or gaps to minimise concealment opportunities</li> <li>→ Anti-concealment base with non-accessible fixings</li> <li>→ Subtle arms support staff in safe de-escalation practices</li> <li>→ Water-resistant, hygienic outer skin which can be easily cleaned and dried for re-use</li> </ul>	<ul style="list-style-type: none"> <li>→ Additional weighted options available</li> <li>→ Available in dual-tone colours:</li> </ul> <div style="display: flex; flex-direction: column; align-items: center;"> <div style="display: flex; align-items: center; margin-bottom: 10px;"> <span style="margin-right: 10px;">Azur Blue</span> <div style="display: flex; gap: 10px;"> <div style="width: 15px; height: 15px; background-color: #1a4d4d; border-radius: 50%;"></div> <div style="width: 15px; height: 15px; background-color: #4a86e8; border-radius: 50%;"></div> </div> </div> <div style="display: flex; align-items: center;"> <span style="margin-right: 10px;">London Grey</span> <div style="display: flex; gap: 10px;"> <div style="width: 15px; height: 15px; background-color: #555555; border-radius: 50%;"></div> <div style="width: 15px; height: 15px; background-color: #808080; border-radius: 50%;"></div> </div> </div> </div>	





# LEVO



Seat static weight tested to



**Levo reduced-ligature recliner**  
 Standard weight (90kg): 1LV1-00  
 Added weight (134kg): 1LV1-134

Upright dimensions:  
 1229H | 852W | 1283D (mm)  
 Reclined dimensions:  
 881H | 852W | 1833D (mm)

*A comfortable, safe solution for Mental Health Crisis Assessment Services*

## KEY FEATURES

- Reclining motion is controlled with body weight - no controls or power required
- Concealed internal mechanism designed to minimise ligature risks
- The generous width seat provides comfort during periods of sitting and napping
- The high-back design offers head and neck support
- Robust and hygienic polyethylene base
- Base is made from 100% recyclable materials

## OPTIONS

- Available with additional weighting (134kg)
- Seat and back available in a wide range of water-resistant upholstery
- Arms and base available in 13 versatile colours





# KORGEN



Seat static weight tested to  317KG



**Korgen chair**  
1KGG1  
855H | 541W | 625D (mm)  
Seat height: 450mm  
Weight: 15kg



**Korgen 2-seater**  
1KGG2  
855H | 1081W | 625D (mm)  
Seat height: 450mm  
Weight: 26kg





**Korgen 3-seater**  
1KGG3  
855H | 1621W | 625D (mm)  
Seat height: 450mm  
Weight: 37kg



**Korgen chair with table**  
(left or right position)  
1KGG1-TT  
855H | 1081W | 625D (mm)  
Seat height: 450mm  
Weight: 26kg



**Korgen 2-seater with table**  
(left, right or middle position)  
1KGG2-TT  
855H | 1621W | 625D (mm)  
Seat height: 450mm  
Weight: 37kg

KEY FEATURES	OPTIONS
<ul style="list-style-type: none"> <li>→ Extremely strong 45mm powdercoated steel tube frame</li> <li>→ Totally water-resistant and UV stabilised for outdoor use</li> <li>→ Anti-bacterial additive and tested for Coronavirus resistance</li> <li>→ No crevices for dirt to be trapped</li> </ul>	<ul style="list-style-type: none"> <li>→ Armrests for additional support (can be applied to one or both sides)</li> <li>→ Compact laminate table provides space for belongings and encourages social distancing</li> <li>→ Available with floor fixing kit for additional security</li> </ul>
	<ul style="list-style-type: none"> <li>→ Choose from 2 frame colours</li> </ul>  <ul style="list-style-type: none"> <li>→ Choose from 2 core seat colours or 8 other colours</li> </ul> 





# BODEN



Static weight tested to  227KG



**Boden beanbag chair**  
1BOCHAIR1-100  
900H | 1000W | 1050D (mm)  
Weight: 12kg



**Boden beanbag**  
1BO1-100  
800H | 900W | 900D (mm)  
Weight: 13kg



**Boden extra large beanbag**  
1BO1-200  
560H | 1400Ø (mm)  
Weight: 23kg



**Boden donut beanbag**  
1BODONUT1-100  
650H | 1350Ø (mm)  
Weight: 27kg

*Filling made from 100% recycled content*

KEY FEATURES	OPTIONS	
→ Double-stitched seams and non-accessible zips prevent tampering	→ Wide choice of water-resistant upholstery (we recommend a dark coloured wipe-clean vinyl)	
→ Flame retardant filling gives the beanbags their shape and comfort (made from 100% recycled content)		
→ Internal seam lining provides an extra layer of protection		

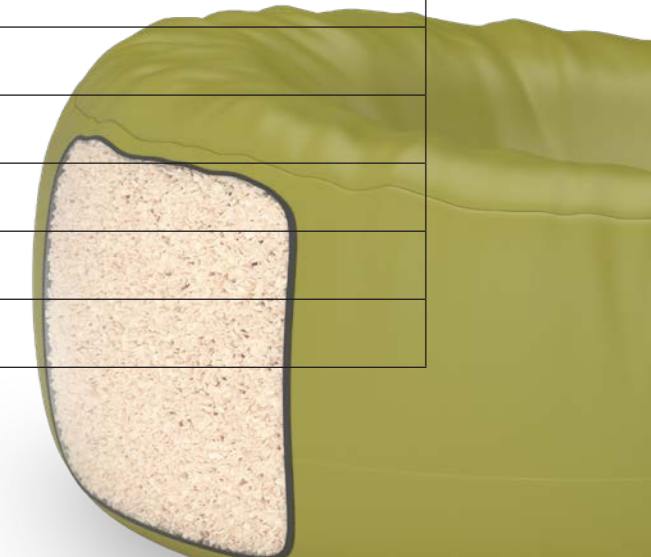

# EVIDENCE-BASED DESIGN

As part of the development process of the Boden Rocker, we trialled a prototype at two mental health hospitals (Adult and CAMHS) and sought feedback from healthcare professionals.

This valuable feedback helped our design team to refine the design to achieve maximum benefit for the users and caregivers.

## ✓ DESIGNED IN ASSOCIATION WITH HDR

The Boden Rocker was designed in association with Jason Beshore, Health Principal at HDR Architecture.

As part of his work designing behavioural health spaces, he noted patients self-soothing by rocking back and forth on the floor rather than using available rocking chairs. After talking to care providers and conducting research to learn more, Jason presented us with a concept, and our product design team set to work bringing this concept into reality, creating a prototype which was trialled in a live environment.

## ✓ TACTILE, PROPRIOCEPTIVE AND VESTIBULAR INPUTS

The Rocker is designed to provide gentle, controllable vestibular stimulation, helping to comfort and calm those in crisis.

The shape, size and softness of the product also offer tactile (touch) and proprioceptive (sense of body positioning) inputs which provide a supportive feeling of reassuring wrap-around contact.

These attributes are particularly important in mental health settings where staff are unable to provide physical contact like a reassuring hug to those in crisis.

## ✓ A SUSTAINABLE CHOICE

As part of the manufacturing process of our other seating products, small pieces of waste foam are generated. We use this waste foam as fillings for our beanbags, reducing our CO2 emissions.

The plastic base of the Rocker is made from 100% recycled polyethylene.

The Boden Rocker is made from 64% recycled content, which means the carbon footprint of the product is reduced from 173kg to 47kg of CO<sub>2</sub> – a 72% decrease.



*“The patient’s seclusion/restraint episodes decreased in frequency by nearly 75%.  
When the patient did have episodes of aggression or self-injury, they were significantly shorter and less intense overall”*

Watch the video ↗



Jason Beshore  
Health Principal





# BODEN ROCKER



*Rocking motion provides comfort and calm*



**Boden Rocker**  
 1BO1-600  
 770H | 1300W | 1350D (mm)  
 Weight: 40kg



NIGHTINGALE AWARDS 2023 **Gold Award**

NIGHTINGALE AWARDS 2023 **Innovation Award**

## KEY FEATURES

- Gentle, controllable vestibular stimulation provides comfort and calm
- Donut shape provides a reassuring feeling of wrap-around contact
- Seating position close to the ground provides a feeling of safety
- Raised back offers head and neck support

- Large size and weight prevents the beanbag being picked up
- Recycled plastic base which is textured to provide grip and prevent the product moving along the floor
- Made from 64% recycled content, contributing to a 72% reduction in CO2 emissions

## OPTIONS

- Available in a wide range of water-resistant upholstery











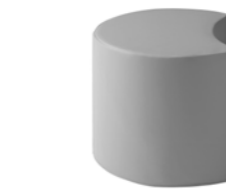

# CONTESSA

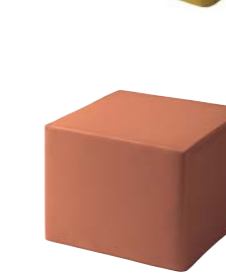
Static weight tested to  227KG

 <p><b>Contessa cube</b> 1COFC-100 460H   575W   575D (mm) Weight: 9kg</p>	 <p><b>Contessa caterpillar</b> 1COFCAT-100 460H   ø 575 (mm) Weight: 5.5kg</p>	
 <p><b>Contessa drum</b> 1COFD-100 460H   575 diameter (mm) Weight: 7.5kg</p>	 <p><b>Contessa 90° curve</b> 1COF90-100 460H   815W   575D (mm) Weight: 15kg</p>	 <p><b>Contessa cuboid</b> 1COFCUB-100 460H   1150W   575D (mm) Weight: 19kg</p>
 <p><b>Contessa extra large drum</b> 1COFD-300 500H   ø 750 (mm) Weight: 23.5kg</p>	 <p><b>Contessa extra large cube</b> 1COFC-400 500H   600W   600D (mm) Weight: 19.5kg</p>	 <p><b>Contessa 45° curve</b> 1COF45-100 460H   660W   575D (mm) Weight: 7kg</p>

KEY FEATURES	OPTIONS	
<ul style="list-style-type: none"> <li>→ All foam construction with no internal frame for safety</li> <li>→ Zip heads removed and oversewn to prevent tampering</li> <li>→ Strong stitched seams</li> </ul>	<ul style="list-style-type: none"> <li>→ Wide choice of water-resistant upholstery (we recommend a dark coloured wipe-clean vinyl)</li> </ul> 	<p><i>CMHR foam provides a sturdy, fire-resistant core</i></p>

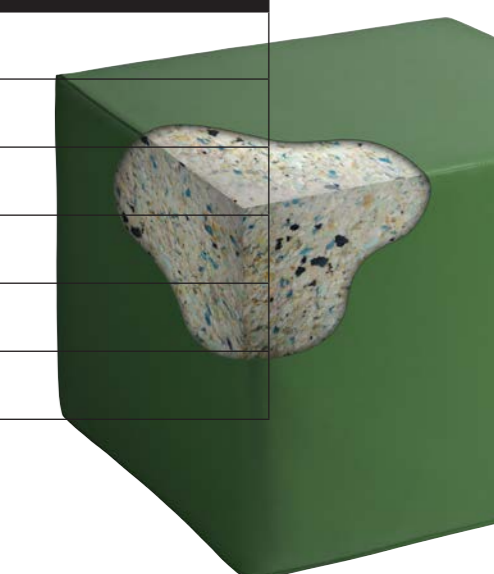



# CASCADE

# CASCADE PLUS

*Anti-vandal material*



**Cascade low back chair**  
1CASL-100  
930H | 600W | 920D (mm)  
Seat height: 430mm



**Cascade Plus low back chair**  
1CSL-100  
930H | 600W | 920D (mm)  
Seat height: 430mm



**Cascade Plus low back calm chair**  
1CSCL-100  
930H | 670W | 1050D (mm)  
Seat height: 430mm



**Cascade Plus high back calm bench**  
1CSCBH-100  
1200H | 1800W | 1095D (mm)  
Seat height: 430mm



**Cascade low back calm chair**  
1CASCL-100  
930H | 670W | 1050D (mm)  
Seat height: 430mm



**Cascade Plus high back chair**  
1CSH-100  
1200H | 600W | 920D (mm)  
Seat height: 430mm



**Cascade Plus high back calm chair**  
1CSM-100  
1200H | 670W | 1100D (mm)  
Seat height: 430mm

KEY FEATURES - CASCADE
→ All-foam construction for safety
→ Strong stitched seams (please note, fluids can penetrate stitching)
→ Zip heads removed and oversewn to prevent tampering
→ Wedge at the front of the Calm chair to aid de-escalation

KEY FEATURES - CASCADE PLUS
→ Strong anti-vandal, tear-resistant material
→ All-foam construction for safety
→ Strong stitched seams (please note, fluids can penetrate stitching)
→ Zip heads removed and oversewn to prevent tampering
→ Wedge at the front of Calm chairs to aid de-escalation

OPTIONS
→ Cascade is available in a wide choice of water-resistant upholstery (we recommend a dark coloured wipe-clean vinyl)
→ Cascade Plus is available in four versatile colours



# ECLIPSE



**Eclipse low back chair**  
1ECL1-100  
870H | 800W | 680D (mm)  
Seat height 500mm



**Eclipse high back chair**  
1ECH1-100  
1080H | 800W | 680D (mm)  
Seat height 500mm



**Eclipse footstool**  
1ECS-100  
350H | 535W | 365D (mm)



**Eclipse low back 2-seater**  
1ECL2-100  
870H | 1300W | 680D (mm)  
Seat height 500mm



**Eclipse high back 2-seater**  
1ECH2-100  
1080H | 1300W | 680D (mm)  
Seat height 500mm

KEY FEATURES	OPTIONS	
<ul style="list-style-type: none"> <li>→ Wings on all high backs for comfort and support</li> <li>→ Fixed seat and back cushions</li> <li>→ Tapered solid wood feet</li> </ul>	<ul style="list-style-type: none"> <li>→ Wide choice of water-resistant upholstery</li> </ul> 	



# VEE



Seat static weight tested to  227KG



**Vee armchair**  
1VE1-200  
830H | 565W | 640D (mm)  
Seat height 460mm  
Weight: 9.5kg



**Vee side chair**  
1VE1-100  
830H | 490W | 640D (mm)  
Seat height 460mm  
Weight: 8kg



**Vee Hijena armchair**  
1VH1-400  
830H | 565W | 640D (mm)  
Seat height 460mm  
Weight: 10kg

*Stylish and strong bent plywood frame*

KEY FEATURES	OPTIONS	
→ One-piece back and seat for strength and durability	→ Frame available in Natural and Walnut finish	
→ Strong bent plywood frame	→ Wide choice of water-resistant upholstery	
→ Stackable for easy storage		
→ Hijena chair features a hygiene-gap to prevent dust and dirt from gathering		





# THOR



**Thor side chair**  
1TR1-300  
805H | 555W | 560D (mm)  
Seat height: 480mm



**Thor armchair**  
1TR1-400  
805H | 555W | 560D (mm)  
Seat height: 480mm

KEY FEATURES	OPTIONS	
<ul style="list-style-type: none"> <li>→ Strong bent plywood frame</li> <li>→ Hygiene-gap between seat and back to prevent dirt and dust gathering</li> <li>→ Stackable for easy storage</li> </ul>	<ul style="list-style-type: none"> <li>→ Wide choice of water-resistant upholstery</li> </ul> 	<p><i>Versatile stacking chair with bent plywood frame</i></p>





# CHELTENHAM



**Cheltenham chair**  
1CH1-100  
1040H | 610W | 710D (mm)



**Cheltenham chair with armrests**  
1CH1-300  
1040H | 610W | 710D (mm)



**Cheltenham chair with filled sides**  
1CH1-200  
1040H | 610W | 710D (mm)

KEY FEATURES	OPTIONS	
<ul style="list-style-type: none"> <li>→ Extended arms provide additional hand grips to aid sitting and standing</li> <li>→ Stylish curved wood frame</li> <li>→ Loose seat cushion for easy cleaning</li> </ul>	<ul style="list-style-type: none"> <li>→ Frame available in Natural and German oak finish</li> <li>→ Wide choice of water-resistant upholstery</li> </ul> 	



# SLOANE



**Sloane chair**  
1SL1-100  
1050H | 820W | 800D (mm)  
Seat height: 480mm  
Weight: 43.5kg



**Sloane chair with optional headrest**  
1SL1-200  
1050H | 820W | 800D (mm)  
Seat height: 480mm  
Weight: 43.5kg

KEY FEATURES	OPTIONS	
→ Timeless high back design	→ Available in Natural and Walnut feet	
→ Wings for added head support	→ Wide choice of water-resistant upholstery	
→ Removable seat cushion for easy cleaning		

**LOUNGE**

**FURNITURE IDEAL**

**FOR SAFE AND**

**STYLISH LIVING**

**SPACES**





## ROCK COFFEE TABLES



**Rock round coffee table**  
1RKf-600R  
420H | ø 600 (mm)



**Rock square coffee table**  
1RKf-600X600  
420H | 600W | 600D (mm)

KEY FEATURES		
→ Smooth chamfered edge protects top surface from damage		
→ Strong and durable solid birch frame		
→ White laminate top - heat and impact resistant		
→ Matching dining chairs and tables (see pages 159 and 183)		

*Cross-braced skis provide strength and manoeuvrability*



# HARBY COFFEE TABLES

- 
- 2
- 1



**Harby square coffee table**  
1HYF-435x550x550  
435H | 550W | 550D (mm)



**Harby round coffee table**  
1HYF-435x610  
435H | ø 610 (mm)



**Harby rectangular coffee table**  
1HYF-435x550x1000  
435H | 550W | 1000D (mm)



**Harby Plus square coffee table**  
1HYPF-435x550x550  
435H | 550W | 550D (mm)  
Weight: 46kg



**Harby Plus round coffee table**  
1HYPF-435x610  
435H | ø 610 (mm)  
Weight: 30kg



**Harby Plus rectangular coffee table**  
1HYPF-435x550x1000  
435H | 550W | 1000D (mm)  
Weight: 87kg

KEY FEATURES - HARBY	KEY FEATURES - HARBY PLUS	
→ 18mm hickory melamine-faced carcass with 28mm thick tops	→ 18mm hickory melamine-faced carcass with 28mm thick tops	
	→ Heavily weighted to deter misuse	
	→ Enclosed base to prevent concealment	
	→ Security fixings to deter tampering	



# ACUMEN COFFEE TABLES



**Acumen square coffee table**  
1AUF-435x550x550  
435H | 550W | 550W (mm)



**Acumen round coffee table**  
1AUF-435x610  
435H | ø 610 (mm)



**Acumen rectangular coffee table**  
1AUF-435x550x1000  
435H | 550W | 1000W (mm)

KEY FEATURES	OPTIONS	
<ul style="list-style-type: none"> <li>→ Heavily weighted to deter misuse</li> <li>→ Enclosed base to prevent concealment</li> <li>→ Security fixings to deter tampering</li> <li>→ Smooth rounded corners for safety</li> <li>→ Matching lounge range (see page 153)</li> </ul>	<p>→ Available in Hickory and Walnut finish</p> <div style="display: flex; align-items: center; gap: 10px;"> <div style="width: 15px; height: 15px; background-color: #c08040; border-radius: 50%;"></div> <div style="width: 15px; height: 15px; background-color: #404040; border-radius: 50%;"></div> </div>	



# HARBY LOUNGE



**Harby large bookcase**  
1HYE-200  
1800H | 760W | 300D (mm)



**Harby 2 door dresser**  
1HYJ-200  
1800H | 760W | 450D (mm)



**Harby tall storage cupboard**  
1HYG-100  
1800H | 875W | 370D (mm)



**Harby medium bookcase**  
1HYE-100  
1060H | 760W | 300D (mm)



**Harby 2 door cupboard**  
1HYG2-200  
740H | 760W | 450D (mm)



**Harby 2 door + 2 drawer sideboard**  
1HYG2-220  
830H | 894W | 450D (mm)



**Harby 3 door + 3 drawer sideboard**  
1HYG3-330  
830H | 1330W | 450D (mm)

## KEY FEATURES

- 28mm thick tops and 18mm hickory melamine-faced carcass
- Double thickness drawer fronts with 18mm back and sides and 10mm drawer bottoms result in very robust drawers

- Robust 160° opening hinges on all doors
- Durable metal drawer runners

## OPTIONS

- Locks to doors and drawers



# ACUMEN LOUNGE



Acumen large bookcase  
1AUE-200  
1800H | 850W | 300D (mm)



Acumen 2 door + 2 drawer dresser  
1AUJ22-100  
1800H | 946W | 450D (mm)



Acumen 2 door + 2 drawer sideboard  
1AUG22-100  
830H | 946W | 450D (mm)







Acumen 3 door + 3 drawer sideboard  
1AUG3-330  
830H | 1368W | 450D (mm)

## KEY FEATURES

- 28mm thick tops and 18mm hickory melamine-faced carcass
- Double thickness drawer fronts with 18mm back and sides and 8mm drawer bottoms result in very robust drawers
- Scalloped handles and piano hinges reduce ligature risks
- Heavy-duty metal drawer runners (rated to 45kg)
- Specially designed to minimise concealment areas (e.g. underside, between drawers)
- Security fixings to deter tampering
- Heavily weighted to deter misuse
- Smooth rounded corners for safety

## OPTIONS

- Locks to doors and drawers
- Available in:
  - Walnut (with White fronts)  
  - Hickory (with Grey fronts)  



UK Registered Design No. 6195594 (bookcase), 6195601 (2-door dresser), 6195599 (2-door sideboard) & 6195600 (3-door sideboard)



# TV CABINETS



**Harby Plus wall mounted TV cabinet (32")**  
 1HYPN32-500  
 840H | 934W | 235D (mm)  
 Max. TV dimensions  
 545H | 830W | 155D (mm)



**Harby Plus floor standing TV cabinet (42")**  
 1HYPN42-100  
 1631H | 1160W | 485D (mm)  
 Max. TV dimensions  
 690H | 1070W | 395D (mm)



**Acumen wall fixed TV cabinet (32")**  
 1AUN32-500  
 876H | 922W | 235D (mm)  
 Max. TV dimensions  
 545H | 830W | 155D (mm)



**Harby Plus wall mounted TV cabinet (42")**  
 1HYPN42-500  
 990H | 1174W | 235D (mm)  
 Max. TV dimensions  
 690H | 1070W | 155D (mm)



**Acumen wall fixed TV cabinet (42")**  
 1AUN42-500  
 1021H | 1232W | 235D (mm)  
 Max. TV dimensions  
 690H | 1070W | 155D (mm)



**Harby Plus wall mounted TV cabinet (55")**  
 1HYPN55-100  
 1090H | 1428W | 220D (mm)  
 Max. TV dimensions  
 820H | 1350W | 160D (mm)



**Acumen floor standing TV cabinet (42")**  
 1AUN42-100  
 1631H | 1232W | 485D (mm)  
 Max. TV dimensions  
 690H | 1070W | 395D (mm)

KEY FEATURES	OPTIONS
<ul style="list-style-type: none"> <li>→ 8mm clear polycarbonate safety screen</li> <li>→ Securely lockable compartments</li> <li>→ Piano hinges to minimise ligature risks</li> <li>→ Secure ventilation to reduce overheating</li> </ul>	<p>→ Acumen products are available in Hickory and Walnut finish</p> 

UK Registered Design No. 6195608 (wall mounted TV cabinet) & 6195609 (floor standing TV cabinet)

**DINING**

**TABLES AND CHAIRS**

**WELL SUITED FOR**

**CHALLENGING**

**ENVIRONMENTS**



**ROCK** 2 



**Rock chair**  
1RK1-BIR-WHITE  
810H | 520W | 520D (mm)  
Seat height: 460mm  
Weight: 7.5kg



**Rock chair with arms**  
1RK1-300-BIRWHT  
810H | 560W | 550D (mm)  
Seat height: 460mm  
Weight: 7.5kg



**Rock bariatric chair**  
1RKB1-100  
816H | 762W | 601D (mm)  
Seat height: 460mm  
Weight: 9.7kg

KEY FEATURES		
→ Cross-braced skis provide additional strength and manoeuvrability		
→ One-piece seat with wipe-clean laminate surface		
→ Strong and durable solid birch frame		
→ Matching coffee and dining tables (see pages 145 and 183)		
	<p><i>One-piece seat with wipe-clean surface</i></p>	





# MONZA



Seat static weight tested to



**Monza side chair with wooden seat**  
 1MZA1-300  
 870H | 470W | 550D (mm)  
 Seat height: 455mm



**Monza side chair with upholstered seat**  
 1MZA1-100  
 870H | 470W | 550D (mm)  
 Seat height: 480mm

KEY FEATURES
→ Strong and stylish round solid birch legs
→ Plywood seat and back shells, subtly curved for comfort
→ Hygiene gap between seat and back to prevent dust and dirt gathering
→ Strength and stability tested to BS EN 16139:2013 level 2

OPTIONS
→ Wide choice of water-resistant upholstery





# FUSION



**Fusion low back chair**  
1FUDCL-400  
930H | 470W | 650D (mm)  
Seat height: 480mm  
Weight: 50kg



**Fusion high back chair**  
1FUDCH-400  
1100H | 470W | 650D (mm)  
Seat height: 480mm  
Weight: 50kg



**Fusion low back chair with arms**  
1FUACL-400  
930H | 606W | 650D (mm)  
Seat height: 480mm  
Weight: 65kg



**Fusion high back chair with arms**  
1FUACH-400  
1100H | 606W | 650D (mm)  
Seat height: 480mm  
Weight: 65kg

KEY FEATURES	OPTIONS	
<ul style="list-style-type: none"> <li>→ Heavily weighted to 45kg to increase stability and deter misuse</li> <li>→ Fully upholstered with stitched seams and security fixings (no piping or staples)</li> <li>→ Solid beech skis for manoeuvrability</li> <li>→ Solid 18mm thick plywood seat and base panels</li> </ul>	<ul style="list-style-type: none"> <li>→ Wide choice of water-resistant upholstery</li> </ul> 	<p><i>Heavily weighted to 45kg to deter misuse</i></p>



# TOUCH



Seat static weight tested to



**Touch chair**  
1TU1-010  
820H | 460W | 560D (mm)  
Seat height: 410mm  
Weight: 8kg



**Touch barstool in Oyster Grey**  
1TUS-006-OG  
1090H | 460W | 560D (mm)  
Seat height: 680mm  
Weight: 8.5kg



**Storage trolley**  
(Capacity 30 chairs)

## KEY FEATURES

- Multi-purpose stacking chair (stacks up to 12 chairs)
- Durable polypropylene shell with handle cut-out for lifting
- Solid chromed steel rod frame
- One-piece seat with hygienic wipe-clean surface

## OPTIONS

- Available with wheeled storage trolley (capacity 30 chairs)
- Upholstered seat pad
- Choose from 5 vibrant shell colours (barstool available in Grey only)





# XEON PLUS

Seat static weight tested to



**Xeon Plus chair Moonwalk**  
1ENP1-MG  
800H | 565W | 580D (mm)  
Seat height: 430mm  
Weight: 5kg



**Xeon Plus chair Cool Green**  
1ENP1-CG  
800H | 565W | 580D (mm)  
Seat height: 430mm  
Weight: 5kg



**Xeon Plus chair White**  
1ENP1-W  
800H | 565W | 580D (mm)  
Seat height: 430mm  
Weight: 5kg

*Stackable for easy storage*

## KEY FEATURES

- Incredibly strong multi-purpose stacking chair
- One-piece seat with hygienic wipe-clean surface
- UV stabilised water-resistant material is suitable for indoor and outdoor use

## OPTIONS

- Available in Moonwalk Grey, Cool Green and White





## BOLD

Seat static  
weight tested to



**Bold chair Moonwalk**  
1BLD-00-MG  
790H | 520W | 500D (mm)  
Seat Height: 450mm  
Weight: 5.8kg



**Bold chair Cool Green**  
1BLD-00-CG  
790H | 520W | 500D (mm)  
Seat Height: 450mm  
Weight: 5.8kg



**Bold chair Alpine White**  
1BLD-00-W  
790H | 520W | 500D (mm)  
Seat Height: 450mm  
Weight: 5.8kg

*Stackable for  
easy storage*

### KEY FEATURES

- Versatile stacking chair (stacks six high) perfect for bedrooms, learning spaces and cafés
- Robust sled design minimises stress on individual legs, reducing the risk of damage in challenging environments
- Water-resistant, hygienic and easy to clean
- Water-resistant foam seat pad in Grey

- Made from 100% recyclable Polypropylene material, with additives which greatly increase impact resistance and compressive strength
- Strength and stability tested for severe non-domestic use (BS EN 16139:2013 - Level 2)

### OPTIONS

- Available without seat pad
- Available in Moonwalk Grey, Cool Green and Alpine White





# NERO



Seat static weight tested to



**Nero chair**  
 1NO1-200  
 820H | 570W | 460D (mm)  
 Weight: 4kg

*Stackable for easy storage*

KEY FEATURES	OPTIONS	
<ul style="list-style-type: none"> <li>→ Multi-purpose stacking chair</li> <li>→ One-piece seat with hygienic wipe-clean surface</li> <li>→ UV stabilised water-resistant material is suitable for indoor and outdoor use</li> <li>→ Polypropylene reinforced with glass fibre construction</li> </ul>	<p>→ Available in Orange, Blue, Red, Green and Black</p>	



# NEXUS



Seat static weight tested to



**Nexus dining side chair with polished wooden seat**  
1NS1-001  
875H | 480W | 540D (mm)  
Seat height: 450mm



**Nexus dining side chair with upholstered seat**  
1NS1-100  
875H | 480W | 540D (mm)  
Seat height: 480mm



**Nexus dining side chair with upholstered back and seat**  
1NS1-300  
875H | 480W | 540D (mm)  
Seat Height: 480mm



**Nexus dining armchair with polished wooden seat**  
1NS1-200  
875H | 530W | 540D (mm)  
Seat height: 450mm



**Nexus dining armchair with upholstered seat**  
1NS1-200A  
875H | 530W | 540D (mm)  
Seat height: 480mm



**Nexus dining armchair upholstered back and seat**  
1NS1-400  
875H | 530W | 540D (mm)  
Seat height: 480mm

*Braced legs for additional stability and durability*

KEY FEATURES	OPTIONS	
<ul style="list-style-type: none"> <li>→ Strong one-piece wrap around arm</li> <li>→ Braced legs for additional stability</li> <li>→ Corner braces under seat provide additional strength</li> <li>→ Solid beech construction</li> </ul>	<ul style="list-style-type: none"> <li>→ Skis to protect flooring and facilitate movement</li> <li>→ Available in Natural and Walnut finish</li> <li>→ Wide choice of water-resistant upholstery</li> </ul>	

**Please note:** Minimum order quantity four chairs



# TROY



Seat static weight tested to 



**Troy chair**  
1TY1  
860H | 450W | 500D (mm)  
Weight: 7kg



**Troy chair with upholstered seat**  
1TY1-100A  
860H | 450W | 500D (mm)  
Weight: 7kg

*Stackable for easy storage*

KEY FEATURES	OPTIONS	
<ul style="list-style-type: none"> <li>→ Multi-purpose stacking chair</li> <li>→ Strong one-piece seat and back</li> <li>→ Durable welded frame with graphite finish</li> </ul>	<ul style="list-style-type: none"> <li>→ Wide choice of water-resistant upholstery</li> </ul> 	







# BOSS



Seat static weight tested to  317KG



**Boss side chair with wooden seat**  
 1BS1-001  
 880H | 460W | 550D (mm)  
 Seat height: 460mm  
 Weight: 9.5kg





**Boss side chair with padded seat**  
 1BS1-100  
 880H | 460W | 550D (mm)  
 Seat height: 525mm  
 Weight: 10kg



**Boss armchair with wooden seat**  
 1BS1-002  
 880H | 545W | 550D (mm)  
 Seat height: 460mm  
 Weight: 10.5kg



**Boss armchair with padded seat**  
 1BS1-200  
 880H | 545W | 550D (mm)  
 Seat height: 525mm  
 Weight: 11kg

KEY FEATURES	OPTIONS	
<ul style="list-style-type: none"> <li>→ Solid beech construction with 25mm thick seat</li> <li>→ Curved braces between back and seat provide additional strength</li> <li>→ Corner braces under seat and cross bars used between legs for maximum strength</li> </ul>	<ul style="list-style-type: none"> <li>→ Skis to protect flooring and facilitate movement</li> <li>→ Undershelf to minimise ligature risks</li> <li>→ Wide choice of water-resistant upholstery</li> </ul> 	

*Optional skis for ease of movement*

# CUMULUS PLUS

Featuring a solid steel base plate and thick steel pedestal, this table range is heavyweight, strong and stable.

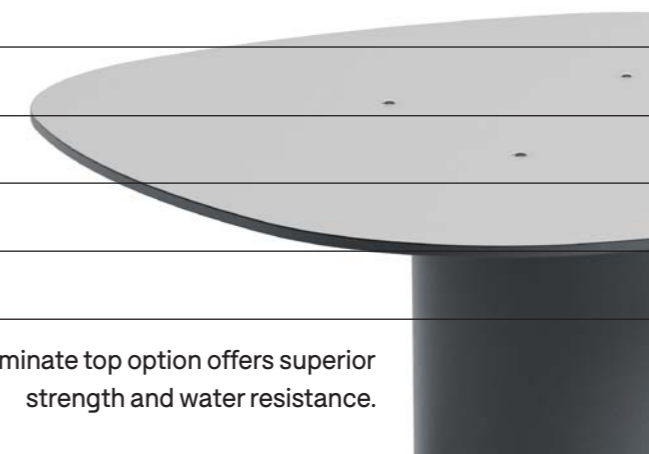

Table tops available in White, Anthracite and Hickory



High-pressure laminate top fixed to durable steel fixing plate with security screws. left

Heavyweight solid steel base plate and pedestal for safety and stability. left



Solid grade laminate top option offers superior strength and water resistance.



Lower height tables available for children.



# CUMULUS PLUS



Static weight tested to  500KG



**Cumulus Plus coffee table**  
1CSPF-7070  
420H | 700W | 700D (mm)  
Weight: 60kg



**Cumulus Plus 700 x 700 square dining table**  
1CSPT-7070  
740H | 700W | 700D (mm)  
Weight: 66kg

**Cumulus Plus 900 x 900 square dining table**  
1CSPT-9090  
740H | 900W | 900D (mm)  
Weight: 71kg

**Cumulus Plus 1200 x 1200 square dining table**  
1CSPT-1212  
740H | 1200W | 1200D (mm)  
Weight: 92kg



**Cumulus Plus 1500 x 900 rectangular dining table**  
1CSPT-1590  
740H | 1500W | 900D (mm)  
Weight: 123kg

**Cumulus Plus 1800 x 900 rectangular dining table**  
1CSPT-1890  
740H | 1800W | 900D (mm)  
Weight: 127kg

## KEY FEATURES

- Heat and impact resistant laminate top
- Solid steel base plate provides strength and stability
- 300mm diameter steel pedestal for added strength
- Heavily weighted to deter misuse
- Suitable for wheelchair users

## OPTIONS

- Table tops available in White, Anthracite and Hickory 
- Solid grade laminate top for superior strength and water resistance
- Lower risk Cumulus tables available
- Lower height (640mm high) tables available for children

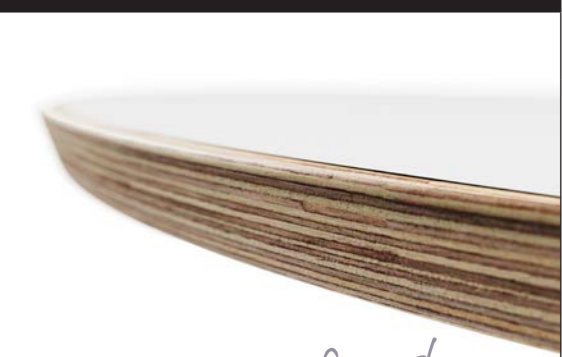

*Optional chamfered edge plywood top*



# ROCK



Static weight tested to 



**Rock round dining table**  
Code: 1RKT-900R  
740H | ø 900 (mm)  
  
Code: 1RKT-1200R  
740H | ø 1200 (mm)



**Rock square dining table**  
Code: 1RKT-9090  
740H | 900W | 900D (mm)  
  
Code: 1RKT-1212  
740H | 1200W | 1200D (mm)



**Rock rectangular dining table**  
Code: 1RKT-1290  
740H | 900W | 1200D (mm)  
  
Code: 1RKT-1590  
740H | 900W | 1500D (mm)  
  
Code: 1RKT-1890  
740H | 900W | 1800D (mm)  
  
Code: 1RKT-1200X2400  
740H | 1200W | 2400D (mm)

## KEY FEATURES

- Smooth chamfered edge protects top surface from damage
- Strong and durable solid birch frame
- White laminate top - heat and impact resistant
- Matching coffee tables and chairs (see pages 145 and 159)

*Chamfered edge protects the top surface from damage*





# FUSION TABLES





**Fusion coffee table**  
 1FUF-400  
 410H | 600W | 600D (mm)  
 Table top: 530 x 530mm  
 Weight: 28kg

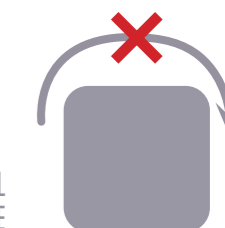

**Fusion dining table**  
 1FUPT-400  
 740H | 1200W | 1200D (mm)  
 Weight: 153kg

HEAVILY WEIGHTED ANTI-ROLL  
 DESIGN TO PREVENT MISUSE

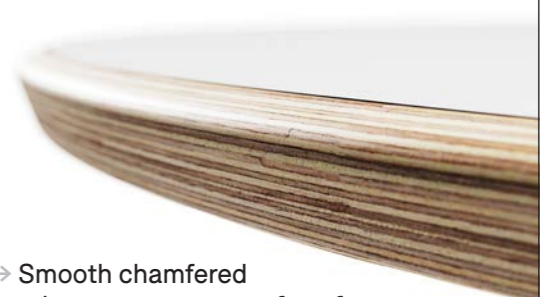

KEY FEATURES	OPTIONS	
<ul style="list-style-type: none"> <li>→ Heavily weighted to increase stability and deter misuse</li> <li>→ Anti-roll design to prevent misuse</li> <li>→ Fully upholstered with stitched seams and security fixings (no piping or staples)</li> <li>→ Solid wood skis for manoeuvrability (reduced ligature design)</li> </ul>	<ul style="list-style-type: none"> <li>→ Available in two-tone upholstered finish</li> <li>→ Wide choice of water-resistant upholstery</li> </ul> 	 <ul style="list-style-type: none"> <li>→ Smooth chamfered edge protects top surface from damage in the event of overturning</li> </ul>



# CANTERBURY PLUS



**Canterbury Plus 1065 x 1065 square dining table**  
 1CBPT-1065X1065  
 740H | 1065W | 1065D (mm)  
 Weight: 44.3kg



**Canterbury Plus 915 x 1980 rectangular dining table**  
 1CBT-915X1980  
 740H | 915W | 1980D (mm)  
 Weight: 59.5kg

**Canterbury Plus 1220 x 1980 rectangular dining table**  
 1CBPT-1220X1980  
 740H | 1220W | 1980D (mm)  
 Weight: 70.8kg



**Canterbury Plus ø 1065 round dining table**  
 1CBPT-1065  
 740H | ø 1065 (mm)

**Canterbury Plus ø 1220 round dining table**  
 1CBPT-1220  
 740H | ø 1220 (mm)  
 Weight: 35.3kg

**Canterbury Plus 915 x 2135 rectangular dining table**  
 1CBT-915X2135  
 740H | 915W | 2135D (mm)  
 Weight: 62.2kg

**Canterbury Plus 1220 x 2135 rectangular dining table**  
 1CBPT-1220X2135  
 740H | 1220W | 2135D (mm)  
 Weight: 71.2kg

**Canterbury Plus 915 x 2440 rectangular dining table**  
 1CBPT-915X2440  
 740H | 915W | 2440D (mm)  
 Weight: 68.2kg

**Canterbury Plus 1220 x 2440 rectangular dining table**  
 1CBPT-1220X2440  
 740H | 1220W | 2440D (mm)  
 Weight: 81.4kg

KEY FEATURES	OPTIONS	
<ul style="list-style-type: none"> <li>→ Extremely substantial table with wood effect laminate top – heat and impact resistant</li> <li>→ Fully cross-braced solid beech frame and 90mm diameter turned legs for extra strength and stability</li> <li>→ Double thickness rails, mortise and tenon jointed into 92mm square corner posts</li> </ul>	<ul style="list-style-type: none"> <li>→ Lower risk Canterbury range available</li> </ul> <p><i>Double thickness rails and cross braced frame create exceptional strength</i></p>	



# HARBY



**Harby 600 x 900 rectangular dining table**  
1HYT-600x900  
748H | 600W | 900D (mm)



**Harby 760 x 1200 rectangular dining table**  
1HYT-760x1200  
748H | 760W | 1200D (mm)



**Harby round dining table**  
1HYT-900  
748H | ø 900 (mm)

**Harby round dining table with laminate top**  
1HYT-909  
748H | ø 900 (mm)

KEY FEATURES	OPTIONS	
→ Natural wood effect melamine top for easy cleaning	→ Round table available with heat and impact resistant laminate top	
→ Solid beech frame with tapered legs		
→ Softened edges for safety		



# ORIANA



**Oriana square dining table**  
1OAT-1  
740H | 915W | 915D (mm)



**Oriana round dining table**  
1OAT-6  
740H | ø 1065 (mm)



**Oriana rectangular table**  
1OAT-8  
740H | 760W | 1220D (mm)



**Oriana rectangular table**  
1OAT-5  
740H | 915W | 1830D (mm)



**Oriana round dining table**  
1OAT-915  
740H | ø 915 (mm)



**Oriana round dining table**  
1OAT-1220  
740H | ø 1220 (mm)



**Oriana rectangular table**  
1OAT-915X1525  
740H | 915W | 1525D (mm)



**Oriana 'D-end' table**  
1OAT-915X1675-DEND  
740H | 915W | 1675D (mm)

## KEY FEATURES

- Natural wood effect laminate top  
- heat and impact resistant
- Bent plywood legs with softened edges for safety
- Suitable for wheelchair users



**BEDROOM**

**FURNITURE FOR PRIVATE**

**SPACES WHERE SAFETY**

**IS PARAMOUNT**



# HARBY



**Harby 1 door, 1 drawer bedside cabinet**  
1HYB-110  
590H | 400W | 450D (mm)



**Harby 1 drawer bedside cabinet**  
1HYB-100  
590H | 400W | 450D (mm)



**Harby 3 drawer bedside cabinet**  
1HYB-300  
590H | 400W | 450D (mm)



**Harby 3 drawer wide chest**  
1HYC-300  
590H | 760W | 450D (mm)



**Harby 4 drawer wide chest**  
1HYC-400  
740H | 760W | 450D (mm)



**Harby 4 drawer desk**  
1HYD-400  
740H | 1050W | 600D (mm)

KEY FEATURES	OPTIONS	
→ 28mm thick tops and 18mm hickory melamine-faced carcass	→ Locks to doors and drawers	
→ Double thickness drawer fronts with 18mm back and sides and 10mm drawer bottoms result in very robust drawers	→ Available as Harby Plus with reduced ligature handles (see pages 198-203)	
→ Robust 160° opening hinges on all doors		
→ Durable metal drawer runners		

# HARBY



**Harby 1 door wardrobe**  
1HYW-100  
1800H | 600W | 600D (mm)



**Harby 2 door wardrobe**  
1HYW-200  
1800H | 875W | 600D (mm)



**Harby combination wardrobe**  
1HYWC-200  
1800H | 875W | 600D (mm)

# HARBY



**Harby 1/2 hanging,  
1/2 shelved wardrobe**  
1HYWH-200  
1800H | 875W | 600D (mm)



**Harby wall mirror**  
1HYK-100  
600H | 500W | 18D (mm)

KEY FEATURES	OPTIONS	
<ul style="list-style-type: none"> <li>→ 28mm thick tops and 18mm hickory melamine-faced carcass</li> <li>→ Double thickness drawer fronts with 18mm back and sides and 10mm drawer bottoms result in very robust drawers</li> <li>→ Robust 160° opening hinges on all doors</li> <li>→ Durable metal drawer runners</li> </ul>	<ul style="list-style-type: none"> <li>→ Locks to doors and drawers</li> <li>→ Available as Harby Plus with reduced ligature handles (see pages 224-229)</li> </ul>	

KEY FEATURES	OPTIONS	
<ul style="list-style-type: none"> <li>→ 28mm thick tops and 18mm hickory melamine-faced carcass</li> <li>→ Double thickness drawer fronts with 18mm back and sides and 10mm drawer bottoms result in very robust drawers</li> <li>→ Robust 160° opening hinges on all doors</li> <li>→ Durable metal drawer runners</li> </ul>	<ul style="list-style-type: none"> <li>→ Locks to doors and drawers</li> <li>→ Available as Harby Plus with reduced ligature handles (see pages 198-203)</li> </ul>	





## HARBY PLUS



**Harby Plus 1 door, 1  
drawer bedside cabinet**  
1HYPB-110  
590H | 400W | 450D (mm)



**Harby Plus 1 drawer  
bedside cabinet**  
1HYPB-100  
590H | 400W | 450D (mm)



**Harby Plus 3 drawer  
bedside cabinet**  
1HYPB-300  
590H | 400W | 450D (mm)



**Harby Plus 3 drawer  
wide chest**  
1HYPC-300  
590H | 760W | 450D (mm)



**Harby Plus 4 drawer  
wide chest**  
1HYPC-400  
740H | 760W | 450D (mm)



**Harby Plus 4 drawer desk**  
1HYPD-400  
740H | 1050W | 600D (mm)

### KEY FEATURES

- 28mm thick tops and 18mm hickory melamine-faced carcass
- Double thickness drawer fronts with 18mm back and sides and 10mm drawer bottoms result in very robust drawers

- Handles styled to reduce ligature risks
- Piano hinges to reduce ligature risks
- Drawer stops prevent removal of drawers
- Security fixings as standard

### OPTIONS

- Locks to doors and drawers
- 270° hinges to reduce risk of damage

# HARBY PLUS



**Harby Plus 1 door wardrobe**  
1HYPW-100  
1800H | 600W | 600D (mm)



**Sloping top single wardrobe**  
1HYPWT-100  
410H | 600W | 600D (mm)



**Harby Plus 2 door wardrobe**  
1HYPW-200  
1800H | 875W | 600D (mm)



**Harby Plus combination wardrobe**  
1HYPWC-200  
1800H | 875W | 600D (mm)

# HARBY PLUS



**Harby Plus 1/2 hanging, 1/2 shelved wardrobe**  
1HYPWH-200  
1800H | 875W | 600D (mm)



**Harby Plus twin hanging wardrobe**  
1HYPW22-200  
1800H | 875W | 600D (mm)



**Sloping top double wardrobe**  
1HYPWT-200  
410H | 875W | 600D (mm)



**Harby Plus polycarbonate wall mirror**  
1HYPK-100  
600H | 500W | 18D (mm)

KEY FEATURES		OPTIONS
→ 28mm thick tops and 18mm hickory melamine-faced carcass	→ Fixed shelves to prevent misuse	→ Locks to doors and drawers → 270° hinges to reduce risk of damage → Sloping top to prevent climbing and allow thorough inspection
→ Double thickness drawer fronts with 18mm back and sides and 10mm drawer bottoms result in very robust drawers	→ Handles styled to reduce ligature risks	
→ Half-depth reduced-ligature shelf	→ Piano hinges to reduce ligature risks	
	→ Drawer stops prevent removal of drawers	
	→ Security fixings as standard	

KEY FEATURES		OPTIONS
→ 28mm thick tops and 18mm hickory melamine-faced carcass	→ Piano hinges to reduce ligature risks	→ Locks to doors and drawers → 270° hinges to reduce risk of damage → Sloping top to prevent climbing and allow thorough inspection
→ Half-depth reduced-ligature shelf	→ Security fixings as standard	
→ Fixed shelves to prevent misuse		
→ Handles styled to reduce ligature risks		



# HARBY PLUS OPEN



**Harby Plus Open twin hanging wardrobe**  
1HYPWO22-200  
1800H | 875W | 600D (mm)



**Harby Plus Open 1/2 hanging, 1/2 shelved wardrobe**  
1HYPOWH-200  
1800H | 875W | 600D (mm)



**Sloping top double wardrobe**  
1HYPWT-200  
410H | 875W | 600D (mm)



**Harby Plus Open chest with 4 compartments**  
1HYPCO-400  
740H | 760W | 450D (mm)



**Harby Plus Open desk with 4 compartments**  
1HYPDO-400  
740H | 1050W | 600D (mm)



**Harby Plus Open bedside with 3 compartments**  
1HYPBO-300  
590H | 400W | 450D (mm)

## KEY FEATURES

- 28mm thick tops and 18mm hickory melamine-faced carcass
- Designed without doors for safety and durability
- Half-depth shelf with groove instead of clothes rail to minimise ligature risks

- Fixed shelves with reinforcement panels to prevent misuse
- Security fixings as standard

## OPTIONS

- Sloping top to prevent climbing and allow thorough inspection

*Designed without doors and drawers to further reduce ligature risks*

# ACUMEN

Acumen has been specially designed for challenging environments with reduced-ligature features and minimised concealment opportunities.

Enclosed underside eliminates concealment opportunities. *below*



Half-depth shelf with groove instead of clothes rail to minimise ligature risks. *above*



Inset handles reduce ligature risks. *above*

Continuous hinges minimise ligature risks. *right*

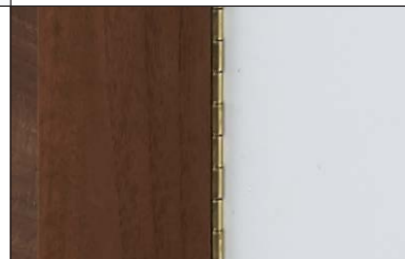

Curved door tops and optional sloping top prevent climbing and allow inspection. *right*

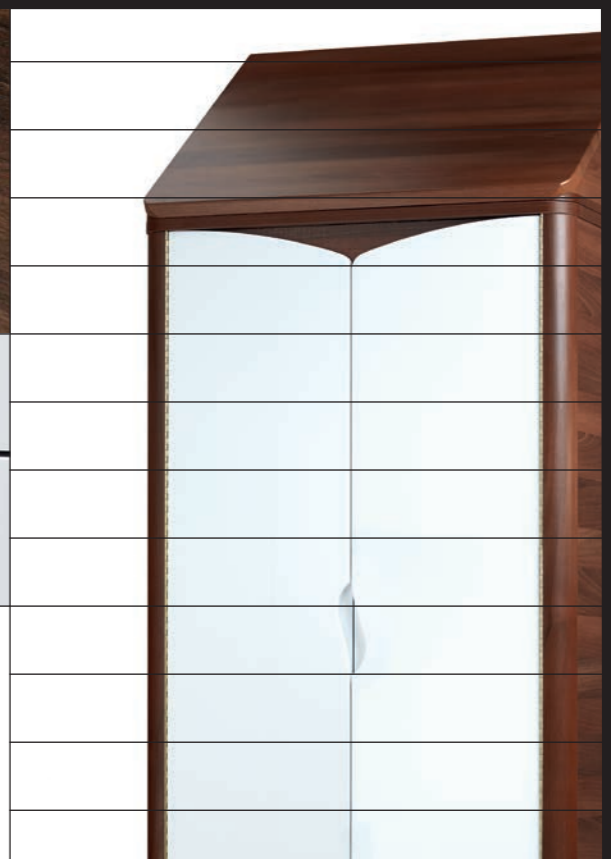

Drawer fronts are inset into the cabinet for added durability. *left*

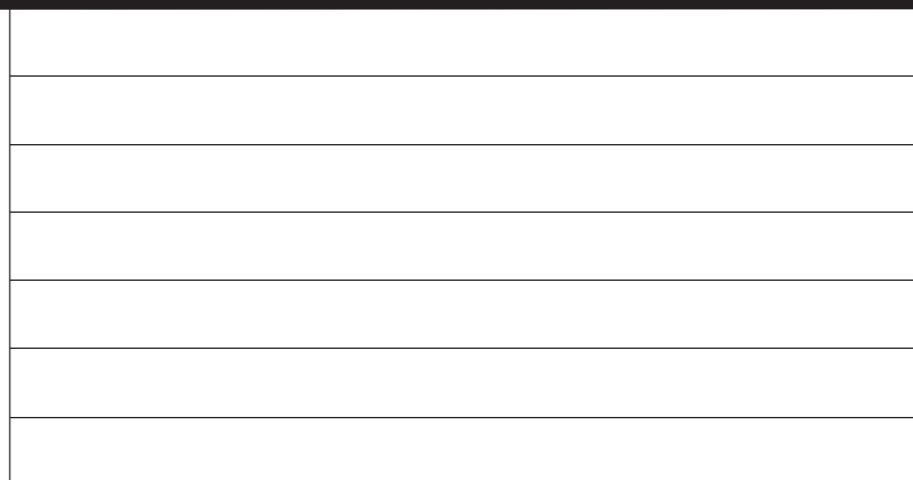

Strong cam and dowel construction with glued wooden dowels for added durability.

Security fixings to deter tampering.



Heavy-duty drawer runners with 45kg load carrying capacity.

10mm thick bottom creates added rigidity.



# ACUMEN



**Acumen 1-door, 1-drawer  
bedside cabinet**  
1AUB-101-HG  
595H | 450W | 480D (mm)  
Weight: 36.5kg



**Acumen 4-drawer  
wide chest**  
1AUC-400-HG  
835H | 810W | 485D (mm)  
Weight: 82kg



**Acumen 4-drawer  
desk**  
1AUD-400-HG  
735H | 1085W | 485D (mm)  
Weight: 79kg

**Acumen wall mirror**  
1AUK-001-H  
500H | 600W | 18D (mm)  
Weight: 6kg



**Acumen 2-door  
wardrobe**  
1AUW2-001-HG  
1800H | 925W | 635D  
Weight: 110kg



**Acumen combination  
wardrobe**  
1AUWC-001-HG  
1800H | 925W | 635D (mm)  
Weight: 139kg



**Acumen 1/2 hanging, 1/2  
shelved wardrobe**  
1AUWH-001-HG  
1800H | 925W | 635D (mm)

**Sloping top**  
1AUWT-001-W  
460H | 925W | 635D (mm)



## KEY FEATURES

- 28mm thick tops and 18mm hickory melamine-faced carcass
- Double thickness drawer fronts with 18mm back and sides and 10mm drawer bottoms result in very robust drawers
- Scalloped handles, piano hinges and curved door tops reduce ligature risks
- Heavy-duty drawer runners (rated to 45kg)
- Half-depth shelf with a groove instead of clothes rail to minimise ligature risks
- Specially designed to minimise concealment areas (e.g. underside, between drawers)
- Heavily weighted to deter misuse
- Security fixings to prevent tampering

## OPTIONS

- Locks to doors and drawers for security
- Wardrobes available with sloping top box to prevent climbing
- Also available in Walnut finish with White doors





# ACUMEN OPEN



**Acumen Open bedside cabinet with 2 compartments**  
1AUOB-200  
595H | 450W | 480D (mm)



**Acumen Open desk with 4 compartments**  
1AUOD-400  
735H | 1085W | 485D (mm)



**Acumen Open wide chest with 4 compartments**  
1AUOC-400  
835H | 810W | 485D (mm)



**Acumen Open ½ hanging, ½ shelved wardrobe**  
1AUOWH-001  
1800H | 925W | 635D (mm)

KEY FEATURES	OPTIONS	
<ul style="list-style-type: none"> <li>→ 28mm thick tops and 18mm melamine-faced carcass</li> <li>→ Half-depth shelf with a groove instead of clothes rail to minimise ligature risks</li> <li>→ Specially designed to minimise concealment areas (e.g. underside, between drawers)</li> <li>→ Stepped shelves to deter climbing</li> <li>→ Fixed shelves with reinforcement panels to prevent misuse</li> <li>→ Heavily weighted to deter misuse</li> <li>→ Security fixings to prevent tampering</li> </ul>	<ul style="list-style-type: none"> <li>→ Sloping top to prevent climbing and allow thorough inspection</li> <li>→ Available in Hickory and Walnut finish</li> </ul> <div style="display: flex; align-items: center; gap: 10px;"> <div style="width: 15px; height: 15px; background-color: #c8a27d; border-radius: 50%;"></div> <div style="width: 15px; height: 15px; background-color: #3d3d3d; border-radius: 50%;"></div> </div>	<p><i>Designed without doors and drawers to further reduce ligature risks</i></p> 



# HARBY BEDS



**Harby single 3' bed**  
1HYA3-100  
395H | 1985L | 990W (mm)



**Harby 4' bariatric bed**  
1HYA4-100  
395H | 1985L | 1280W (mm)



Static weight tested to



**Harby 3' headboard**  
1HYH-300  
600H | 920W | 18D (mm)



**Harby 3' wall-mounted headboard**  
1HYH-301  
870H | 920W | 18D (mm)



**Harby double 4'6" bed**  
1HYA46-100  
395H | 1985L | 1450W (mm)  
(Assembled at point of delivery)



**Harby 3' bed with internal storage**  
1HYA3-500  
395H | 1985L | 990W (mm)

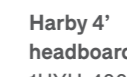

**Harby 4' headboard**  
1HYH-400  
600H | 1220W | 18D (mm)

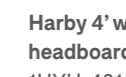

**Harby 4' wall-mounted headboard**  
1HYH-401  
870H | 1220W | 18D (mm)

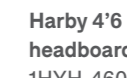

**Harby 4'6" headboard**  
1HYH-460  
600H | 1370W | 18D (mm)

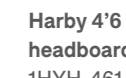

**Harby 4'6" wall-mounted headboard**  
1HYH-461  
600H | 1370W | 18D (mm)

## KEY FEATURES

- 28mm side panels for strength with solid reinforced under rails
- Enclosed base to minimise concealment opportunities
- Heavyweight to deter misuse



# ACUMEN BED



**Acumen single 3' bed**  
 1AUA-101  
 422H | 2002L | 998W (mm)  
 Weight: 95kg



**Acumen double 4'6'' bed**  
 1AUA-460  
 422H | 2002L | 1428W (mm)



**Acumen 3' headboard**  
 1AUH-001  
 600H | 998W | 18D (mm)



**Acumen 3' wall-mounted headboard**  
 1AUH-301  
 870H | 998W | 18D (mm)

**Acumen 4'6'' headboard**  
 1AUH-460  
 600H | 1428W | 18D (mm)

**Acumen 4'6'' wall-mounted headboard**  
 1AUH-461  
 870H | 1428W | 18D (mm)

## KEY FEATURES

- 28mm side panels for strength with solid reinforced under rails
- Enclosed base to minimise concealment opportunities
- Heavyweight to deter misuse
- Smooth rounded corners for safety

## OPTIONS

→ Available in Hickory and Walnut finish



# SOVIE

This range has been designed to provide an ideal safety solution for beds in challenging environments.



**Strength**  
Internal support ribs provide extra strength and durability.



**Water resistance**  
Sovie's one-piece mattress platform has no joints or crevices through which liquid can permeate, preserving hygiene and infection control levels.



## DURA-TEC material

The Sovie bed is coated in DURA-TEC – a tough plastic which is commonly found in aircraft interiors. Kydex is an extremely durable finish which withstands impact and is resistant to tough chemical cleaners.

### Flame retardant

DURA-TEC has flame retardant properties:

- Achieves Class A rating (the highest) for ASTM E-84\* surface burning characteristics of building materials
- Is self extinguishing in the absence of an external flame

### Anti-bacterial

DURA-TEC resists bacterial and fungal development:

- It provides no source of nutrients (unlike some other plastics)
- Passed ASTM G-21\* (bacteria) and ASTM G-22\* (fungus) by supporting no bacterial or fungal growth

### Chemically resistant

DURA-TEC remains unaffected by some of the harshest chemicals:

- 70% Nitric acid
- 30% Sulphuric acid
- 10% Hydrochloric acid
- Ammonia
- 3% Hydrogen



**Installation**  
Beds can be securely fixed to the floor, using infill panels to minimise concealment opportunities when positioned against a wall.



# SOVIE BEDS



Static weight tested to  500KG



**Sovie single 3' box bed**  
 1SVEA-100  
 470H | 1950L | 980W (mm)  
 Mattress tray: 1880L | 910W (mm)  
 Weight: 120kg



**Sovie Flare single 3' bed**  
 1SVFA-100  
 480H | 1990L | 990W (mm)  
 Mattress tray: 1880L | 910W (mm)  
 Weight: 110kg

**Sovie Flare bariatric 4' bed**  
 1SVFAB4-100  
 480H | 2112L | 1200W (mm)  
 Mattress tray: 2032L | 1120W (mm)

KEY FEATURES	OPTIONS	
<ul style="list-style-type: none"> <li>→ Water-resistant one-piece mattress tray</li> <li>→ Internal support ribs provide extra strength and durability</li> <li>→ Extremely resilient DURA-TEC finish which is water-resistant, stain-resistant, anti-bacterial &amp; flame-retardant</li> <li>→ Suitable for use with our foam mattresses                      Single beds: 915 x 1900mm mattress                      Bariatric bed: 1120 x 2032mm mattress</li> </ul>	<ul style="list-style-type: none"> <li>→ Invisible floor fixing method – please advise when placing an order</li> <li>→ Available in White and Hickory finish</li> </ul> <div style="display: flex; align-items: center; gap: 10px;"> <input type="radio"/> <input checked="" type="radio"/> </div>	



# ZURICH BEDS



**Zurich single 3' bed**  
1ZHA-1  
340H | 1905L | 900W (mm)



**Zurich double 4'6" bed**  
1ZHA-2  
340H | 1905L | 1400W (mm)

KEY FEATURES		
→ Extremely strong welded construction with mesh base		
→ Rounded corners for safety		
→ One-piece ski legs for strength		
→ Powder coated tough 50mm x 25mm steel box section frame		



# SCORPIO

2



	Single 3' (915mm)	Small double 4' wide (1220mm)	Double 4'6" wide (1370mm)
5" (125mm) thick	1SOMS-001 125H   1900L   900W (mm)	1SOM4-63-5-C5 125H   1900L   1220W (mm)	1SOM46-63-5-C5 125H   1900L   1370W (mm)
7" (180mm) thick	1SOMS-002 180H   1900L   900W (mm)	1SOM4-63-7-C5 180H   1900L   1220W (mm)	1SOM46-63-7-C5 180H   1900L   1370W (mm)
13" (330mm) thick	1SOM3-63-13-C5 330H   1900L   900W (mm)	1SOM4-63-13-C5 330H   1900L   1220W (mm)	1SOM46-63-13-C5 330H   1900L   1370W (mm)
21" (530mm) thick	1SOM3-63-21-C5 530H   1900L   900W (mm)	1SOM4-63-21-C5 530H   1900L   1220W (mm)	1SOM46-63-21-C5 530H   1900L   1370W (mm)

## KEY FEATURES

- Tear-resistant, fire-retardant, anti-vandal polyurethane cover
- Water-resistant heat-welded seams to prevent liquid penetration – ideal for incontinence
- CMHR foam interior

## OPTIONS

- Available with integral pillow
- Available fire retardant to BS7177 source 5 and BS7177 source 7

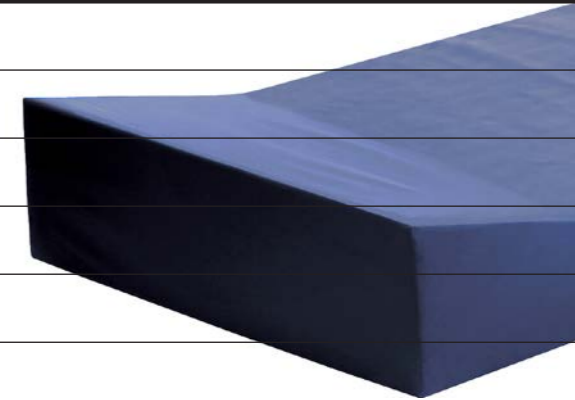

Scorpio mattress for Ryno bed available - see page 57





# SCORPIO COLLAPSIBLE

Versatile design serves multiple functions including making it usable for soft seating.

The patented design of our Scorpio collapsible mattress (No.GB2572141) prevents obscuring of vision panels as it ‘collapses’ when stood on end.

	<p>Available fire-retardant to BS7177 Ignition Source 5 or Ignition Source 7.</p>		<p>An optional security under layer makes damage more noticeable during staff inspection.</p>		<p>Unlike separate pillows, the optional integral pillow cannot be used to as a weapon or to block plumbing.</p>
--	---	--	---	--	--

## SCORPIO COLLAPSIBLE



Scorpio Collapsible anti-vandal foam mattress Crib 5  
1SOM26-63-3-TRIFOLDC5  
76H | 1900L | 760W (mm)

Scorpio Collapsible anti-vandal foam mattress Crib 7  
1SOM26-63-3-TRIFOLDC7  
76H | 1900L | 760W (mm)

KEY FEATURES	OPTIONS	
<ul style="list-style-type: none"> <li>→ Tri-folding design to stop it from being stood on its end as an obstruction to viewing panels</li> <li>→ Tear-resistant, fire-retardant, anti-vandal polyurethane cover</li> <li>→ Water-resistant heat-welded seams to prevent liquid penetration – ideal for incontinence</li> <li>→ CMHR foam interior</li> </ul>	<ul style="list-style-type: none"> <li>→ Available with integral pillow</li> <li>→ Available fire retardant to BS7177 source 5 and BS7177 source 7</li> </ul>	

# POLAR



	Single 3' (915mm)	Small double 4' wide (1220mm)	Double 4'6" wide (1370mm)
5" (125mm) thick	1PRMS-001 125H   1900L   900W (mm)	1PRM4-63-5-C5 125H   1900L   1220W (mm)	1PRM46-63-5-C5 125H   1900L   1370W (mm)
7" (180mm) thick	1PRMS-002 180H   1900L   900W (mm)	1PRM4-63-7-C5 180H   1900L   1220W (mm)	1PRM46-63-7-C5 180H   1900L   1370W (mm)
13" (330mm) thick	1PRAS-001 330H   1900L   900W (mm)	1PRM4-63-13-C5 330H   1900L   1220W (mm)	1PRM46-63-13-C5 330H   1900L   1370W (mm)
21" (530mm) thick	1PRM3-63-21-C5 530H   1900L   900W (mm)	1PRM4-63-21-C5 530H   1900L   1220W (mm)	1PRM46-63-21-C5 530H   1900L   1370W (mm)

## KEY FEATURES

- Hygienic wipe-clean surface
- Water-resistant heat-welded seams to prevent liquid penetration – ideal for incontinence
- CMHR foam interior

## OPTIONS

- Available with integral pillow
- Available fire retardant to BS7177 source 5 or BS7177 source 7

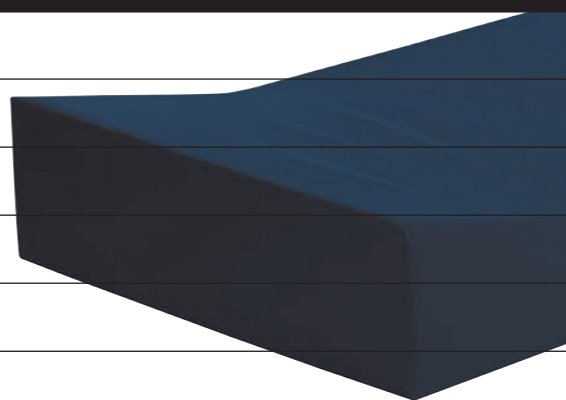

# MONSOON PRESSURE RELIEVING



Monsoon single 3' mattress  
1MNM-001-C5  
180H | 1900L | 915W (mm)

# AQUARIUS



	Single 3' (915mm)	Small double 4' wide (1220mm)	Double 4'6" wide (1370mm)
Mattress	1AQM-002 125H   1900L   915W (mm)	1AQM4-001 125H   1900L   1220W (mm)	1AQM-004 125H   1900L   1370W (mm)
Divan bed base	1AQA-002 400H   1900L   915W (mm)	1AQA4 400H   1900L   1220W (mm)	1AQA-004 400H   1900L   1370W (mm)

## KEY FEATURES MONSOON

- Pressure relieving CMHR foam interior
- Water-resistant heat-welded seams to prevent liquid penetration – ideal for incontinence

## KEY FEATURES AQUARIUS

- Open-coil sprung mattress interior
- Layers of insulation and quilting for comfort
- Water-resistant, anti-bacterial breathable cover

Please note: Fluid can still penetrate stitching.  
For fully waterproof mattresses, please see Polar, Scorpio and Monsoon.

# NEXT STEPS

NOW IT'S TIME TO

MAKE ANY FABRIC

CHOICES AND PLACE

YOUR ORDER

# UPHOLSTERY



We provide an extensive range of water-resistant fabrics and vinyls to ensure that you will find the right finish for your furniture.

## Fabrics

A durable option which combines the comfort of soft fabric with practical water-resistant properties. Please be aware, these fabrics are more susceptible to stains than vinyl.

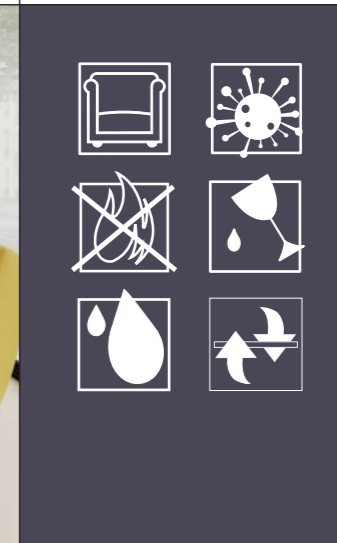

Call us to request your fabric swatch cards to see the full choice available.

## Vinyls

Hard wearing and water-resistant, leather-effect vinyls can be wiped clean which makes them a hygienic and practical option for healthcare environments.

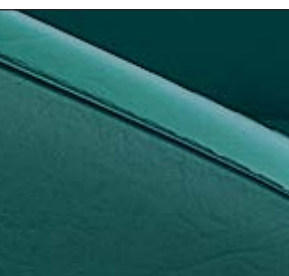



Call us to request your fabric swatch cards to see the full choice available.





Some of our ranges are available using dual fabrics to add multiple textures and colours to one item of furniture.

**Please note:** Cracking and stickiness on vinyl fabrics are known issues to fabric manufacturers. As furniture manufacturers, Pineapple cannot accept responsibility.

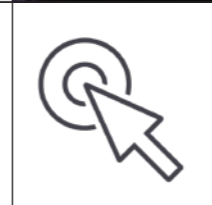
# HOW TO PLACE YOUR ORDER

Step		Step		Step	
<b>01</b>	Pick your furniture	<b>02</b>	Pick your fabric or finish	<b>03</b>	Get in touch for a quote
					
			Visit our website to see our latest fabrics and request a free swatch		

Need assistance? We're on hand to help

	+44 (0) 1622 237830		sales@pineapplecontracts.com		Chat to us at www.pineapplecontracts.com
---	---------------------	---	------------------------------	---	---

# INDEX

<b>Acumen</b>		→ Dining	41, 47, 159-177
→ Lounge	153	→ Lounge	35-39, 43, 132-141
→ TV Cabinets	155	→ Children's chair	47
→ Coffee Tables	149	<b>Cheltenham</b>	139
→ Bedroom	206-211	Children's table	179
→ Open	211	Coffee tables	43, 81, 144-149
→ Bed	215	<b>Coda</b>	105
<b>Aquarius</b>	227	<b>Contessa</b>	129
<b>Aruba</b>	99	<b>Cumulus Plus</b>	178-181
Bariatric chairs	43, 91, 159	Cupboards	151-153
Beds	57, 213-221	De-escalation	106 - 111, 127
Beanbags	122 - 127	Desks	52, 195, 201, 205, 209-211
Benches	45	Dining tables	49-51, 178-191
<b>Bedroom</b>	52-57, 193-227	<b>Doorne Plus</b>	77
→ Bedroom cabinets	52-55, 194-211	<b>Eclipse</b>	133
→ Beds, mattresses & headboards	57, 212-227	Foam beds & mattresses	222-227
<b>Boden</b>	124 - 127	Footstools	72, 79, 133
<b>Bold</b>	169	<b>Fusion</b>	
<b>Boss</b>	177	→ Chairs	163
<b>Cascade / Cascade Plus</b>	131	→ Tables	185
<b>Canterbury Plus</b>	187	<b>Harby</b>	
<b>Chairs</b>		→ Coffee Tables	147

→ Dining	189	→ Lounge chair	43
→ Lounge	151	→ Stool	44
→ Bedroom	194-197	→ Tub chair	39
→ Beds	213	<b>Scorpio</b>	222 - 225
<b>Harby Plus</b>		<b>Seal</b>	112-115
→ Coffee Tables	147	<b>Sigma Plus</b>	65
→ Bedroom	198-205	<b>Skye plus</b>	67
→ TV Cabinets	155	<b>Sloane</b>	141
→ Open	205	Sloping top boxes	202-205, 209
<b>Harrier Plus</b>	97	<b>Snug Plus</b>	79
<b>JAK de-escalation</b>	108 - 111	Sofas	84-115
<b>Korgen</b>	121	<b>Sovie</b>	216-219
<b>Liberty</b>	100-103	Stools	45
<b>Magna Plus</b>	84-87	<b>Tables</b>	
<b>Monsoon</b>	227	→ Coffee	43, 81, 144-149
<b>Monza</b>	161	→ Dining	46-51, 178-191
Mattresses	222-227	<b>Tempo Plus</b>	69
<b>Nero</b>	171	<b>Thor</b>	137
<b>Nexus</b>	173	<b>Touch</b>	165
<b>Ohio Plus</b>	81	<b>Troy</b>	175
<b>Oriana</b>	191	TV Cabinets	155
<b>Osprey Plus</b>	97	<b>Vee</b>	135
<b>Orr Plus</b>	90-93	Wardrobes	53-55, 196-197, 202-205, 209-211
<b>Polar</b>	226	<b>Xeon Plus</b>	167
<b>Purl Plus</b>	71	<b>Zen Plus</b>	73
<b>Quadra Plus</b>	89	→ Rocker	75
<b>Reef de-escalation</b>	107	<b>Zurich</b>	221
<b>Rock</b>			
→ Coffee tables	145		
→ Dining chairs	159		
→ Dining tables	183		
<b>Rubus Plus</b>	95		
<b>Ryno</b>	34-59		
→ Bedroom	52-57		
→ Bench	45		
→ Children's chair	47		
→ Club chair	41		
→ Coffee table	43		
→ Dining chair	47		
→ Dining tables	48-51		

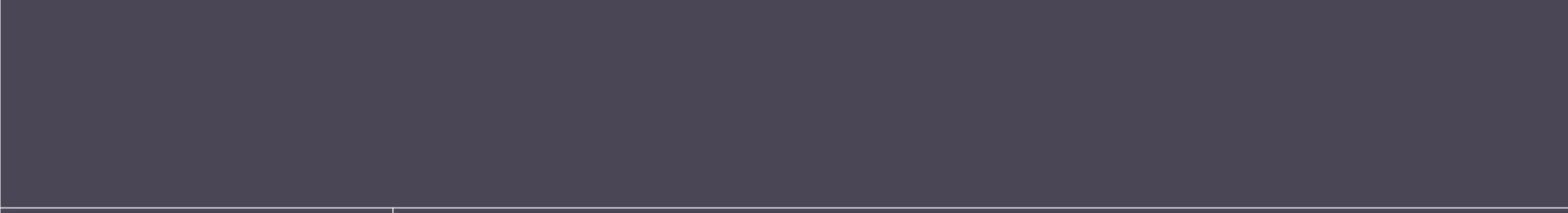

**Pineapple**

 +44 (0)1622 237830

 Pineapple, Westmead, Aylesford, Maidstone, Kent ME20 6XJ

 [pineapplecontracts.com](http://pineapplecontracts.com)

 [sales@pineapplecontracts.com](mailto:sales@pineapplecontracts.com)

